

2 F

DIESER KATALOG IST INTERAKTIV

Die ONLINE Version diese Kataloges ist interaktiv aufgebaut, um Ihnen ein leichteres Navigieren auf Ihrem PC, Tablett und dgl. zu ermöglichen. Im unten stehenden Beispiel finden Sie die Erklärung welche Elemente im Katalog interaktiv sind.

WE CUSTOMIZE YOUR LIGHT

BEISPIEL:

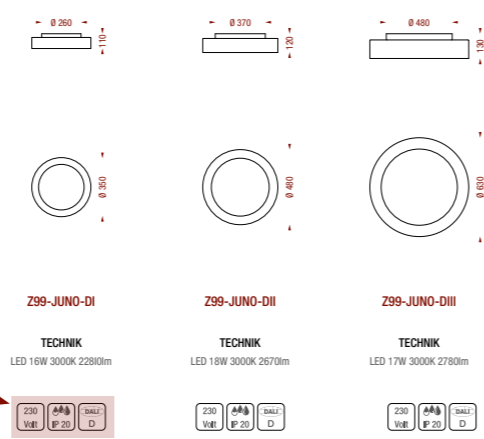
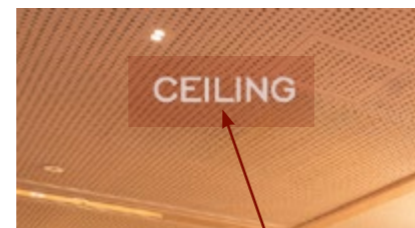

Bei klicken auf die Icons gelangen Sie direkt zur Icon Beschreibung

Bei klicken auf das 2F Logo gelangen Sie ebenfalls auf das Inhaltsverzeichnis

2F Metalloberflächen: 1 • 2 • 4

BEWÄHRTES LEBENDIG HALTEN - TRADITION MATTERS

Im Herzen der Salzburger Berge, mitten im wildromantischen Lammertal sind wir zu Hause. Die Familie als Rückgrat unseres Unternehmens bildet die stärkende Basis für das Selbstbewusstsein und die nötige Motivation, den Herausforderungen der unternehmerischen Gegenwart und Zukunft, in einer harmonischen Verbindung von traditionellen Werten, sorgsam und mit der nötigen Konsequenz zu folgen.

Als Familienunternehmen leitet uns eine gut entwickelte Unternehmenskultur sowie ein hohes regionales Verantwortungsgefühl. Unser Produktionsstandort in Abtenau bei Salzburg, hat Tradition an der wir festhalten, denn mit der regionalen Wertschöpfung steigt auch die Wertschätzung für das Produkt.



2F GESCHICHTE

Das Unternehmen 2F-LEUCHTEN wurde 1972 als Familienbetrieb gegründet und steht seit 2002 im Besitz von Maria und Hans Buchegger. Ursprünglich wurden traditionelle Leuchten in Holz und Schmiedeeisen hergestellt. Heute fertigt das Unternehmen hauptsächlich individuelle Leuchten und Lichtobjekte für Hotels und Shops. Über 80 Mitarbeiter sichern nationalen und internationalen Kunden kurze Lieferzeiten und hohe Flexibilität.

Unser Team kommt zum Großteil aus der Region und verfügt über die unterschiedlichsten Fähigkeiten. 15 Handwerke unter einem Dach vereint: Schlosser, Schmiede, Maler, Tischler, Schneiderinnen, Elektrotechniker, Maschinenbauer, Lichtplaner und Konstrukteure – Spezialisten und Spezialistinnen aus allen Bereichen vereinen ihr Können zu einem großen Ganzen. Jedes Projekt ist individuell und wir unterstützen Kunden und Architekten dabei Einzigartigkeit zu schaffen.

2F-LEUCHTEN ist eine Manufaktur, die sich immer neu erfinden kann. Jedes einzelne gefertigte Modell aus der Vergangenheit oder von Heute, sehen wir als Chance uns zukunftsweisend zu definieren und unsere Lichtlösungen modern zu interpretieren. Wir sind in jeder Phase unseres Schaffens bereit, auch unerforschte Wege zu gehen und neue Wege zu bauen. Wir wachsen mit unserem Handeln und handeln um zu wachsen.



VON DER IDEE ZUR LEUCHE | 5 HANDWERKE UNTER EINEM DACH

Den kreativen Ideen von Architekten und Designern sind in Sachen Leuchten und deren Produktion keine Grenzen gesetzt. In unserer 2F-Werkstatt trifft altes Kunsthandwerk auf moderne, industrielle Methodik – eine Kombi, die es ermöglicht, beinahe alle Entwürfe in die Realität umzusetzen.

Unser Team verfügt über die unterschiedlichsten Fähigkeiten: Schlosser, Maler, Tischler, Schneiderinnen, Elektrotechniker, Maschinenbauer, Lichtplaner und Konstrukteure – Spezialistinnen und Spezialisten aus allen Bereichen vereinen ihr Können zu einem großen Ganzen.



LICHT FÜR MENSCHEN

Unsere Arbeit richtet sich an den Menschen und seinen Bedürfnissen. Unser professionelles Team mit seinen ambitionierten Mitarbeitern erarbeitet mit Feingefühl und Sensibilität aus Geschmack, Vorliebe, Fantasie und Designanspruch unserer Auftraggeber, außergewöhnliche Beleuchtungslösungen die den Benutzer komfortabel und inspirierend begleiten und dabei wirkungsvoll auf Ästhetik, Energieeffizienz, funktionale und technische Anforderungen reagieren.

Intensive Betreuung führt zur nahtlosen Produktabstimmung. Bereits in der Vorbereitungsphase bieten wir an, die Baustellen zu besuchen und die Situation vor Ort zu verstehen. Mit unseren eigenen Augen sehen wir welche Maßnahmen erforderlich sind, um eine optimale Produktion, Verarbeitung und Qualität unserer Beleuchtungslösungen zu gewährleisten.

FERTIGUNG

Dezent oder opulent, klassisch oder modern, Reproduktionen von Leuchten aus vergangenen Epochen (Jugendstil, Empire, Gründerzeit, Klassizismus) auf hohem Niveau handwerklich gefertigt oder ikonische Entwürfe des Art déco, Leuchten aller Stilrichtungen von einfach bis repräsentativ. Traditionelle Materialien kombiniert mit moderner Technik erfordern Experten in der Fertigung und Installation unserer Leuchten. Die Flexibilität, das Geschick und Know-how unserer Mitarbeiter ist unser höchstes Gut. Mit Gespür, Liebe zum Detail und unter Einhaltung der technischen Vorgaben entstehen Meisterwerke der Lichtkunst.

Der von uns angebotene Mix aus Planung, Konstruktion und Entwicklung, Produktion, schneller Lieferung und wenn gewünscht auch Montage, ermöglicht uns eine hohe Flexibilität beginnend von unikalsten Einzelstücken oder Kleinserien bis hin zur Serienfertigung von dekorativen oder technischen Beleuchtungselementen.



PLANUNG

In enger Zusammenarbeit mit Hotelketten, Architekten, Lichtdesignern, Bauunternehmen, Planungsbüros, Kunstinstitutionen und Behörden begleiten wir Ihr Projekt mit Fachwissen, Innovation und jahrzehntelanger Erfahrung im Leuchtenbau.

Individuelles Kundenerlebnis zu personalisieren und unvergesslich zu machen steht im Fokus der Projekte. Die Bedürfnisse von Gästen und Kunden im Kontext von Stil, Präsenz, Wohlfühlfaktor, Variabilität, Energieeffizienz, Nachhaltigkeit, langer Lebensdauer, sowie intelligenten Lichtsteuerungen und innovativer Technik, zählen zu den wichtigsten Prioritäten einer professionellen Lichtplanung. Unterschiedliche Bereiche werden in verschiedenen Funktionen von Menschen genutzt und sind deshalb auch für die Beleuchtungsplanung von besonderer Bedeutung. Licht soll das Erlebnis der visuellen Umgebung verbessern.

Zuverlässige und frühzeitig durchdachte Lichtplanungen sorgen im Vorfeld nicht nur für die Auswahl der richtigen Leuchten. Eine Vielfalt an unterschiedlichen Beleuchtungsthemen wie Arbeits- und Grundbeleuchtung, Hintergrundbeleuchtung, Akzentbeleuchtung, Erlebnisbeleuchtung benötigen eine jeweils differenzierte Betrachtung.

TECHNIK

Bei Licht geht es nicht nur um Beleuchtungsstärken, sondern verstärkt um die visuelle Wahrnehmung. Speziell bei der Verwendung von LED's, die über eine sehr hohe Leuchtdichte verfügen, ist es wesentlich, Streustrahlung zu vermeiden, das Licht exakt zu verteilen und klare Bereiche zu definieren.

In unseren jüngsten Serienproduktentwicklungen setzen wir daher ganz klar auf innovative state of the art Technologien. Kundenspezifische Anforderungen an Funktionalität, Effizienz, Abstrahlcharakteristik, visuellen Komfort, High Performance und Eleganz führen wir in eine konsequent zeitgemäße Mariage von Form und Funktion (Technischer Katalog von 2F-Leuchten „YOUR LIGHT YOUR CHOICE“).



LEISTUNGEN

- Beratung
- Planung/Projektierung
- Entwicklung von individuellen Beleuchtungskonzepten
- Konstruktion und Machbarkeitsstudie
- Anwendungsbezogenes Prototyping und Musterbau
- Technische Planung und Produktion der Beleuchtung
- Lieferung
- Installation, Montage und Programmierung der Beleuchtungssteuerung (auf Wunsch)

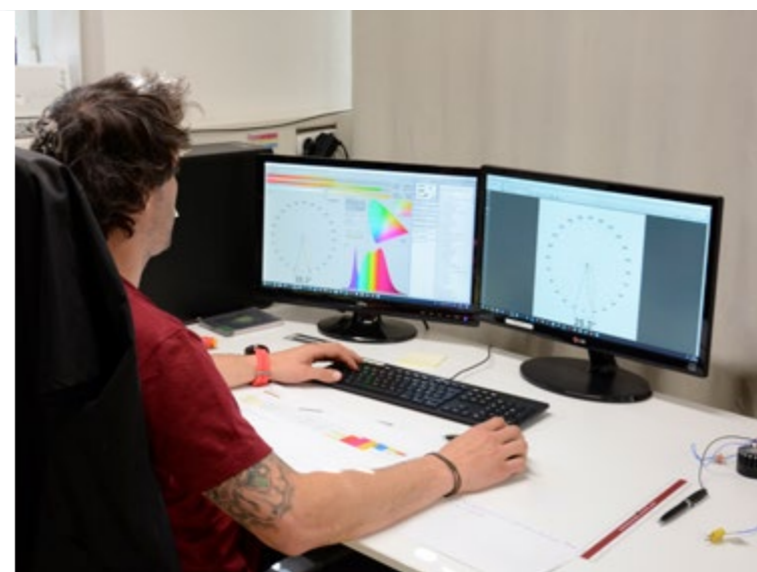
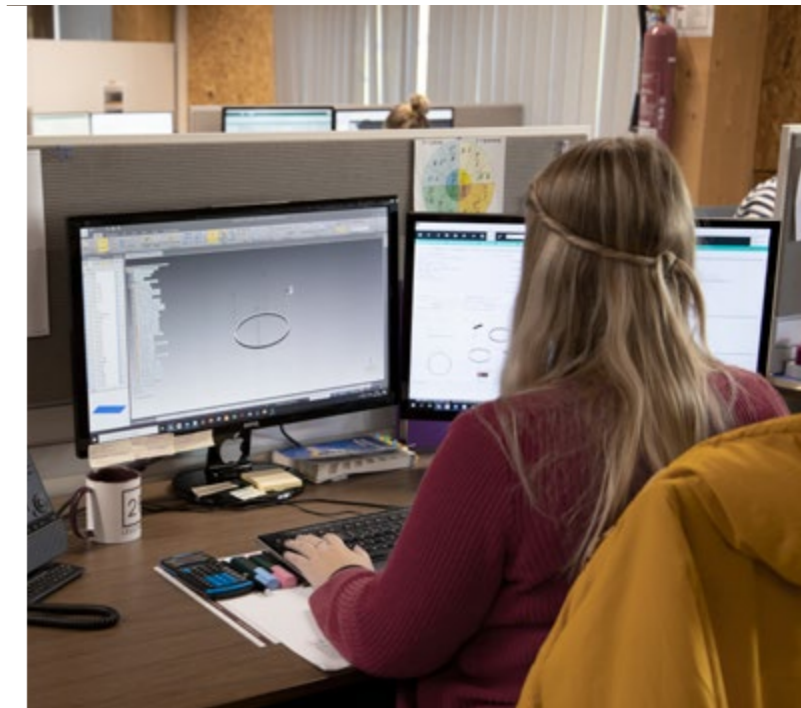

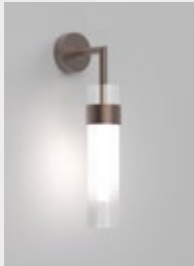

WALL

14 - 31



TABLE

32 - 43

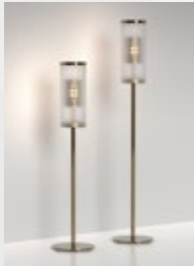

FLOOR

44 - 55



CEILING

56 - 79



SUSPENSION

80 - 125



ANGLE

126 - 129



BUCKET

130 - 135



COMBI

136 - 143



CURLING

144 - 147

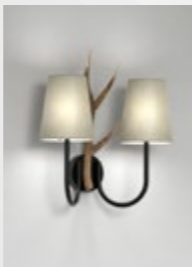

DEER

148 - 151

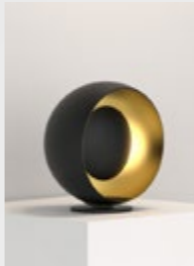

ECLIPSE

152 - 155



ELEGANCE

156 - 159



GLOBE

160 - 163



GRATE

164 - 167



HAMBURG

168 - 173



KUBA

174 - 179



LENS

180 - 183



LONDON

184 - 189



MALMÖ

190 - 193



MUG

194 - 199

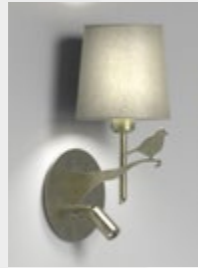

NATURE
200 - 205



NEW YORK
206 - 209

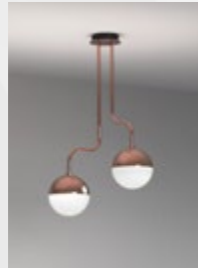

ORBIT
210 - 213



OSLO
214 - 217



PARIS
218 - 223

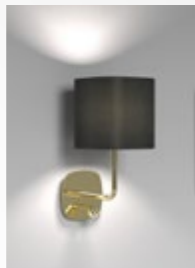

PEPPLE
224 - 231



PRINCIPLE
232 - 237

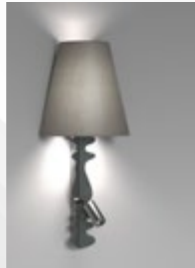

RUSTICA
238 - 243

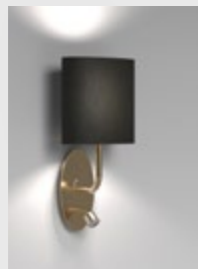

SEED
244 - 251

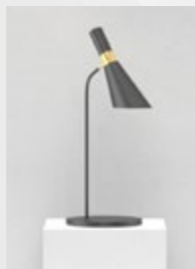

TAPER
252 - 255



READING
256 - 263



READING MODULAR
264 - 267



OUTDOOR
268 - 285

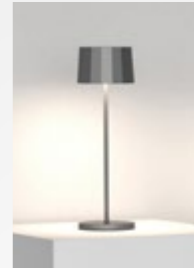

BATTERY
286 - 289

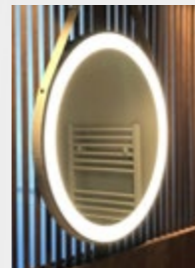

MIRROR
290 - 295

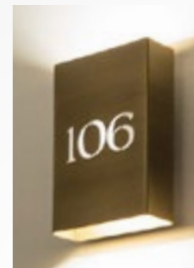

ROOM NUMBER
296 - 299

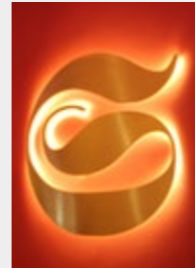

SIGNS
300 - 305



PROJEKTS
306 - 317

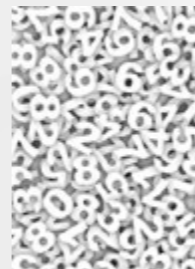

SEARCH
318 - 319



LEGEND
320 - 321



WALL



WALL

Z99-W0781 • Z99-W5497 • Z99-W3199-1

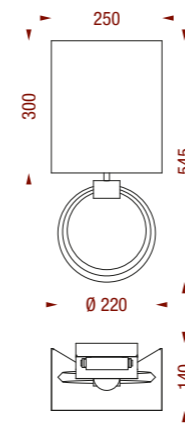

Z99-W0461-3

TECHNIK

1x E27
 1x R7s

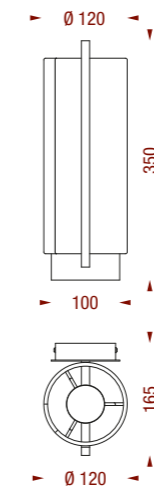

Z99-W0781

TECHNIK

1x E27

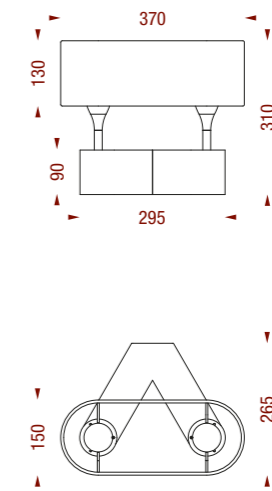

Z99-W5497

TECHNIK

2x LED 5W 2700K 450lm

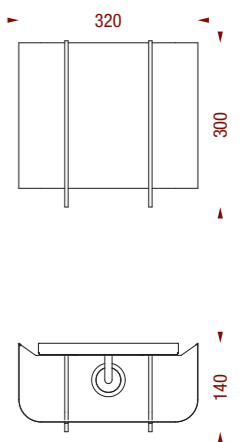

Z99-W3199-1

TECHNIK

1x E27



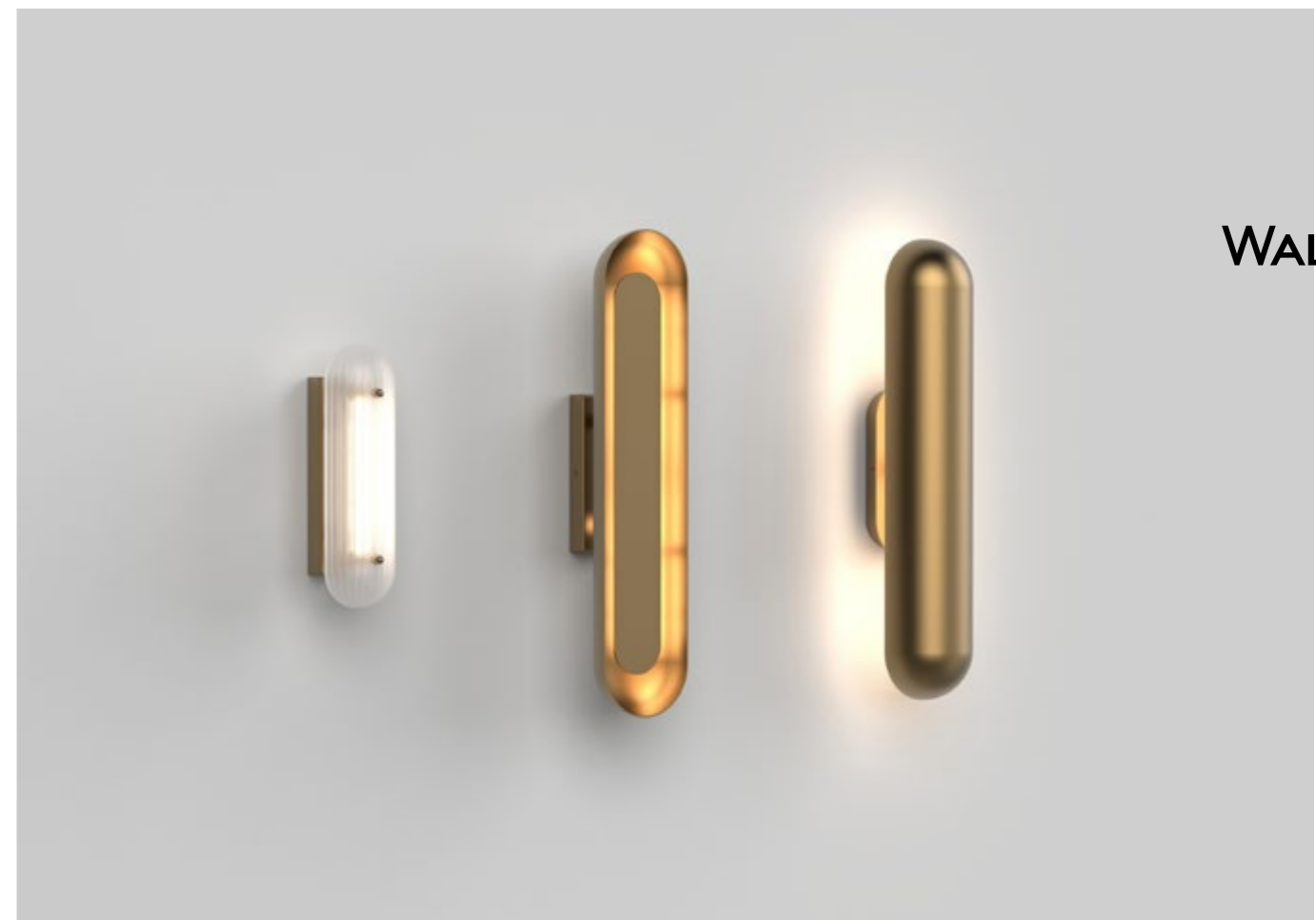

Z99-W0955 • Z99-W0953-1 • Z99-W0550-1

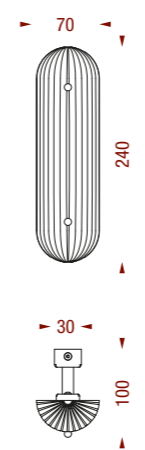

Z99-W0955

TECHNIK
LED 5W 2700K 700lm 500mA

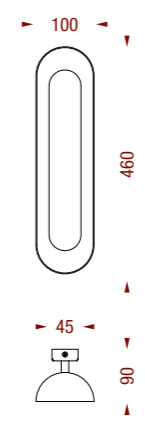

Z99-W0953-1

TECHNIK
LED 3,5W 2700K 160lm

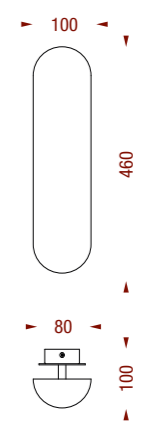

Z99-W0550-1

TECHNIK
LED 3,5W 2700K 600lm





WALL

Z99-LTGH-100 • Z99-W5478-1 • Z99-W5460-6 • Z99-W1603-1

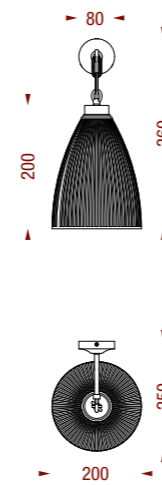

Z99-LTGH-100

TECHNIK

1x E27

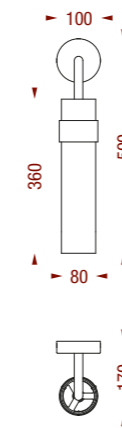

Z99-W5478-1

TECHNIK

LED 19W 2700K 1000lm

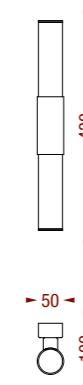

Z99-W5460-6

TECHNIK

2x LED 8W 2700K 300lm

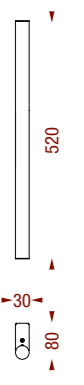

Z99-W1603-1

TECHNIK

LED 7W 2700K 600lm





Z99-W5643 • Z99-W1586-1 • Z99-W5543

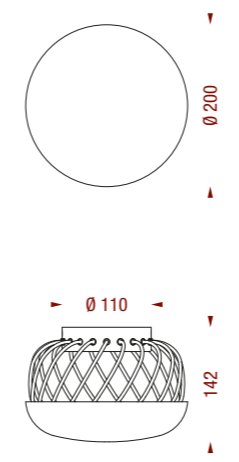

Z99-W5643

TECHNIK
LED 9W 2700K 700lm

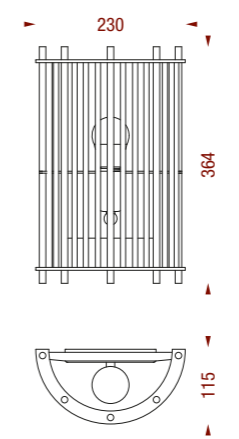

Z99-W1586-1

TECHNIK
1x E27

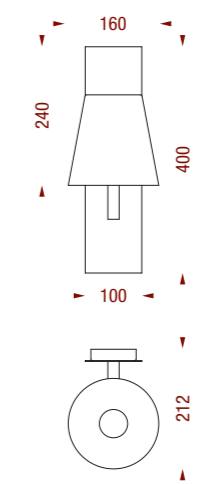

Z99-W5543

TECHNIK
1x E27

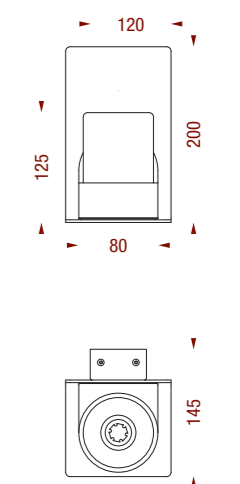

Z99-W0460-1

TECHNIK
LED 2W 2700K 160lm

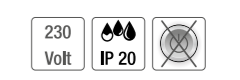



Z99-W0420-R-1

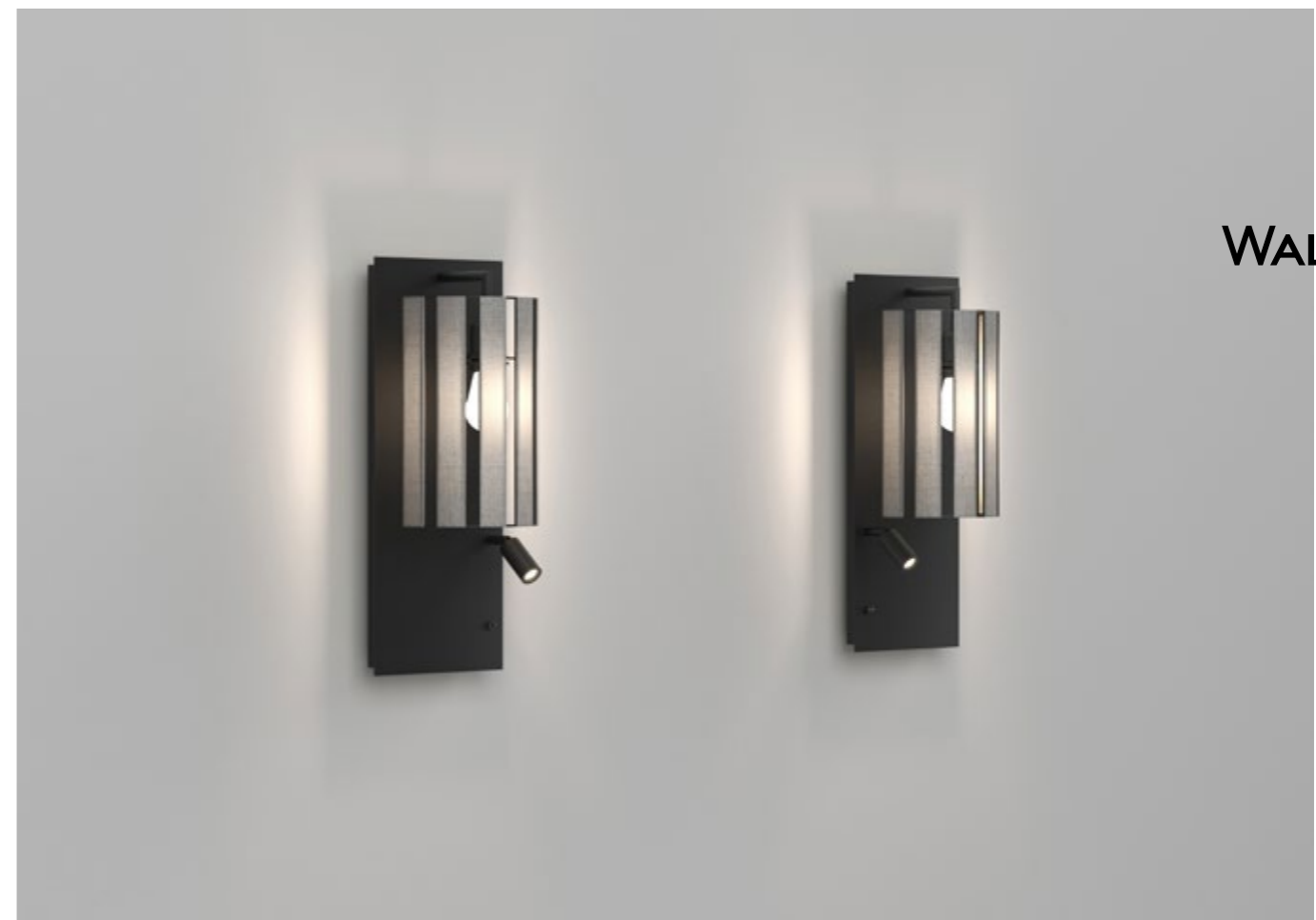

WALL

Z99-W0420-R-1 • Z99-W0420-L-1

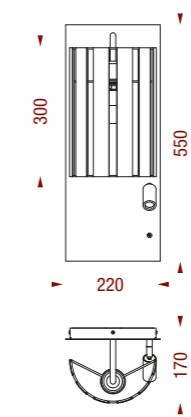

Z99-W0420-R-1

TECHNIK
1x E27
+LED 2W 2700K 160lm

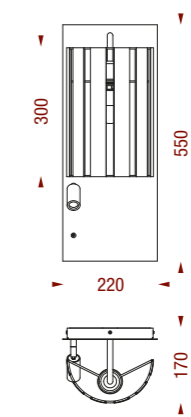
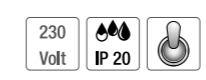

Z99-W0420-L-1

TECHNIK
1x E27
+LED 2W 2700K 160lm



Metalloberflächen: 1 • 2 • 3 • 4
Stoffoberflächen: 1 • 2 • 3



Z99-W0947
H2 - HOTEL OLYMPIAPARK • München

© guidoanackerphotographie



WALL

Z99-W5541 • Z99-W0721-4

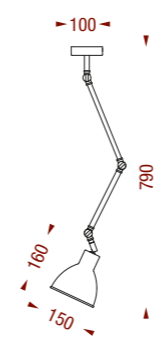

Z99-W0721-4

TECHNIK
1x E27

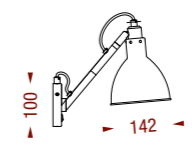

Z99-W5541

TECHNIK
1x E27

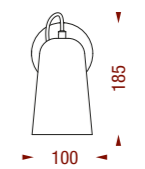

Z99-W0947

TECHNIK
1x E27





Z99-W0221-3 • Z99-W0221-4

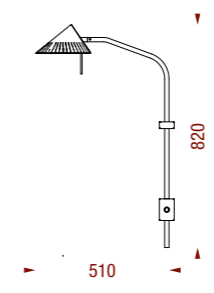

Z99-W0221-3

TECHNIK
LED LED 5W 2700K 480lm

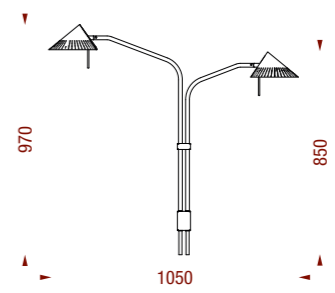

Z99-W0221-4

TECHNIK
2x LED LED 5W 2700K 480lm



Z99-W0221-3



WALL

Z99-W0276

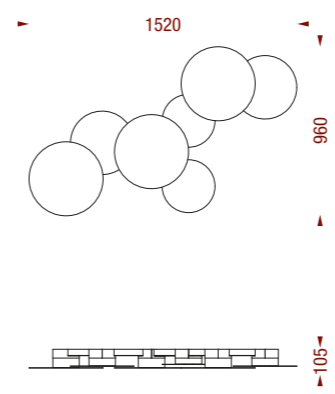

Z99-W0276

TECHNIK
LED 42W 2700K 2800lm

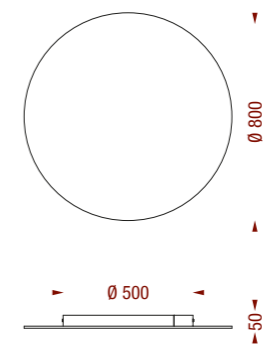

Z99-W5582

TECHNIK
LED 30W 2700K 2400lm

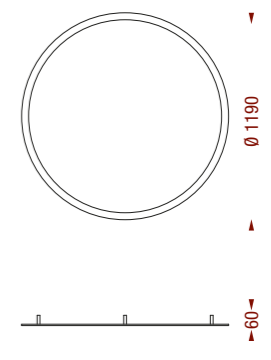

Z99-W0808-1200

TECHNIK
LED 45W 2700K 3900lm



TABLE





TABLE

Z99-T1015-500 • Z99-T0502

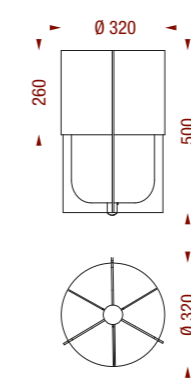

Z99-T1015-500

TECHNIK
1x E27

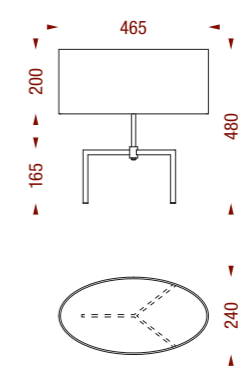

Z99-T0502

TECHNIK
1x E27





TABLE

Z99-T4674-1 • Z99-T0548-2

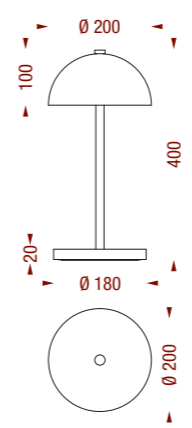

Z99-T4674-1

TECHNIK
LED 16W 3000K 1000lm

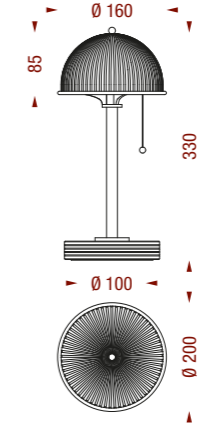

Z99-T4185-1

TECHNIK
1x E14

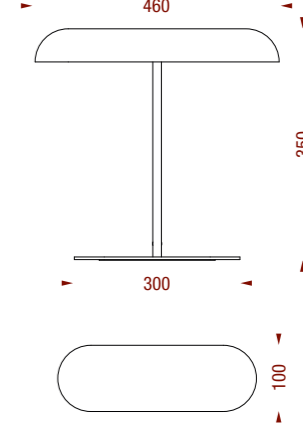

Z99-T0548-2

TECHNIK
LED 3,5W 2700K 600lm





TABLE

Z99-MR141 • Z99-T0498-1 • Z99-T0416-1

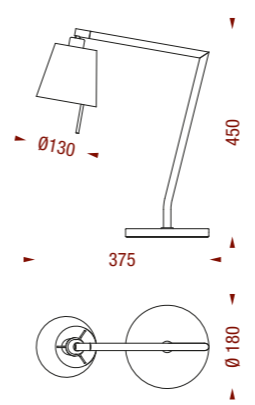

Z99-T0227

TECHNIK
1x E14

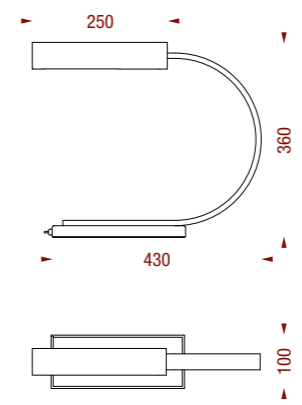

Z99-MR141

TECHNIK
1x E27

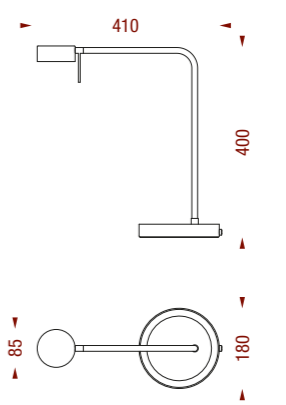

Z99-T0498-1

TECHNIK
LED 6W 2700K 400lm

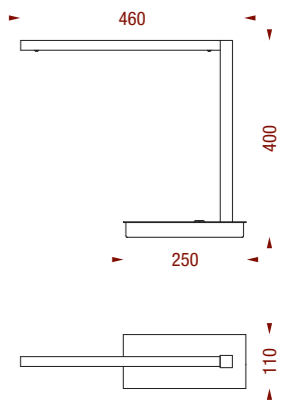

Z99-T0416-1

TECHNIK
LED 15W 2700K 800lm





Z99-T4911



TABLE

Z99-T4911

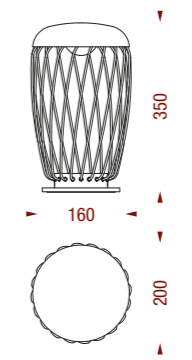

Z99-T4911

TECHNIK
LED 9W 2700K 700lm

230 Volt  



TABLE

Z99-T0399-7 • Z99-T0399-5

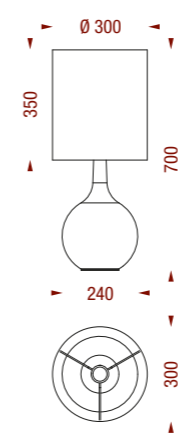

Z99-T0399-7

TECHNIK
1x E27

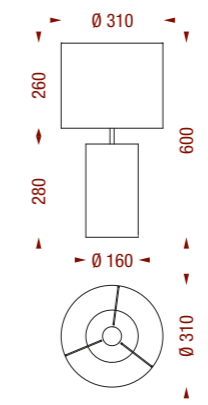

Z99-T0399-5

TECHNIK
1x E27

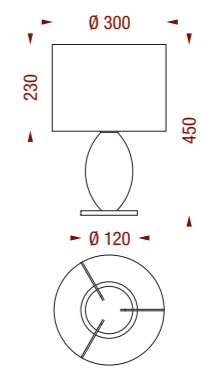

Z99-T0244-1

TECHNIK
1x E27



FLOOR





FLOOR

Z99-S0535-1400 • Z99-S0535-1720

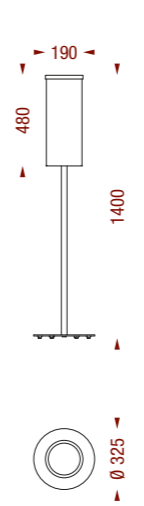

Z99-S0535-1400

TECHNIK
1x E27

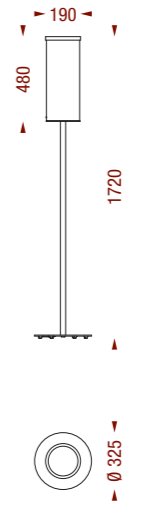

Z99-S0535-1720

TECHNIK
1x E27





Z99-S0490-1



FLOOR

Z99-S0474 • Z99-S0473

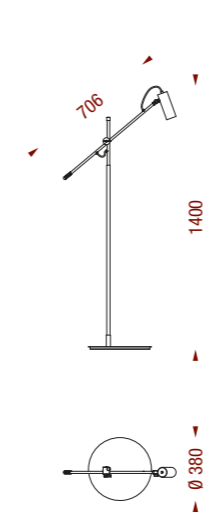

Z99-S0490-1

TECHNIK
1x GU10

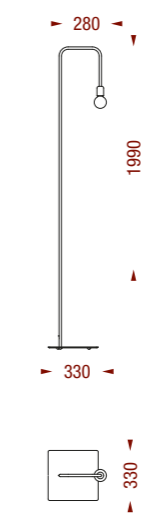

Z99-S0473

TECHNIK
1x E27

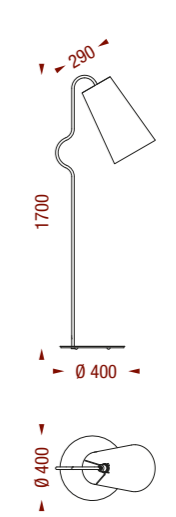
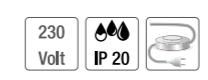

Z99-S0474

TECHNIK
1x E27



2F Metalloberflächen: 1 • 2 • 3 • 4
Stoffoberflächen: 1 • 2 • 3



FLOOR

Z99-S4129-10

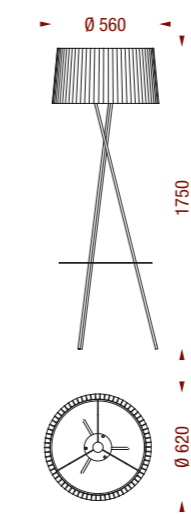

Z99-S4129-10

TECHNIK
1x E27

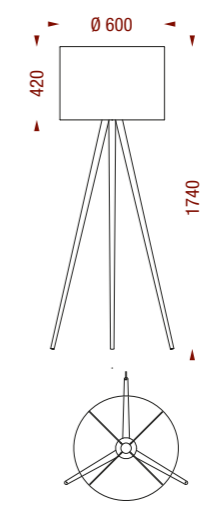

Z99-S4129-41

TECHNIK
1x E27





Z99-S4723



FLOOR

Z99-S4723 • Z99-1064-1430

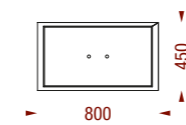
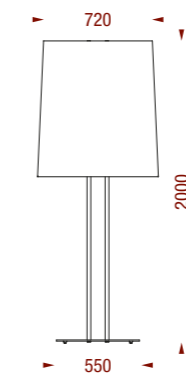

Z99-S4723

TECHNIK

2x E27

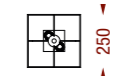
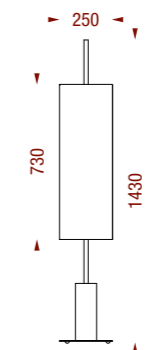

Z99-S1064-1430

TECHNIK

3x E27



2F

Metaloberflächen: 1 • 2 • 3 • 4
Stoffoberflächen: 1 • 2 • 3



Z99-S0169-3

SONNGASTEIN • Bad Hofgastein

© Gerhard Wolkersdorfer



FLOOR

Z99-S0169-3

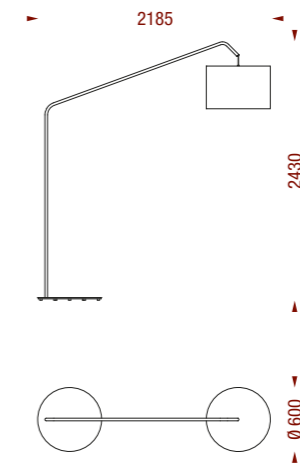

Z99-S0169-3

TECHNIK

3x E27



2F

Metalloberflächen: 1 • 2 • 4
Stoffoberflächen: 1 • 2 • 3

CEILING





Z99-D650-DOWN40
HOTEL ZEHNERKAR • Obertauern

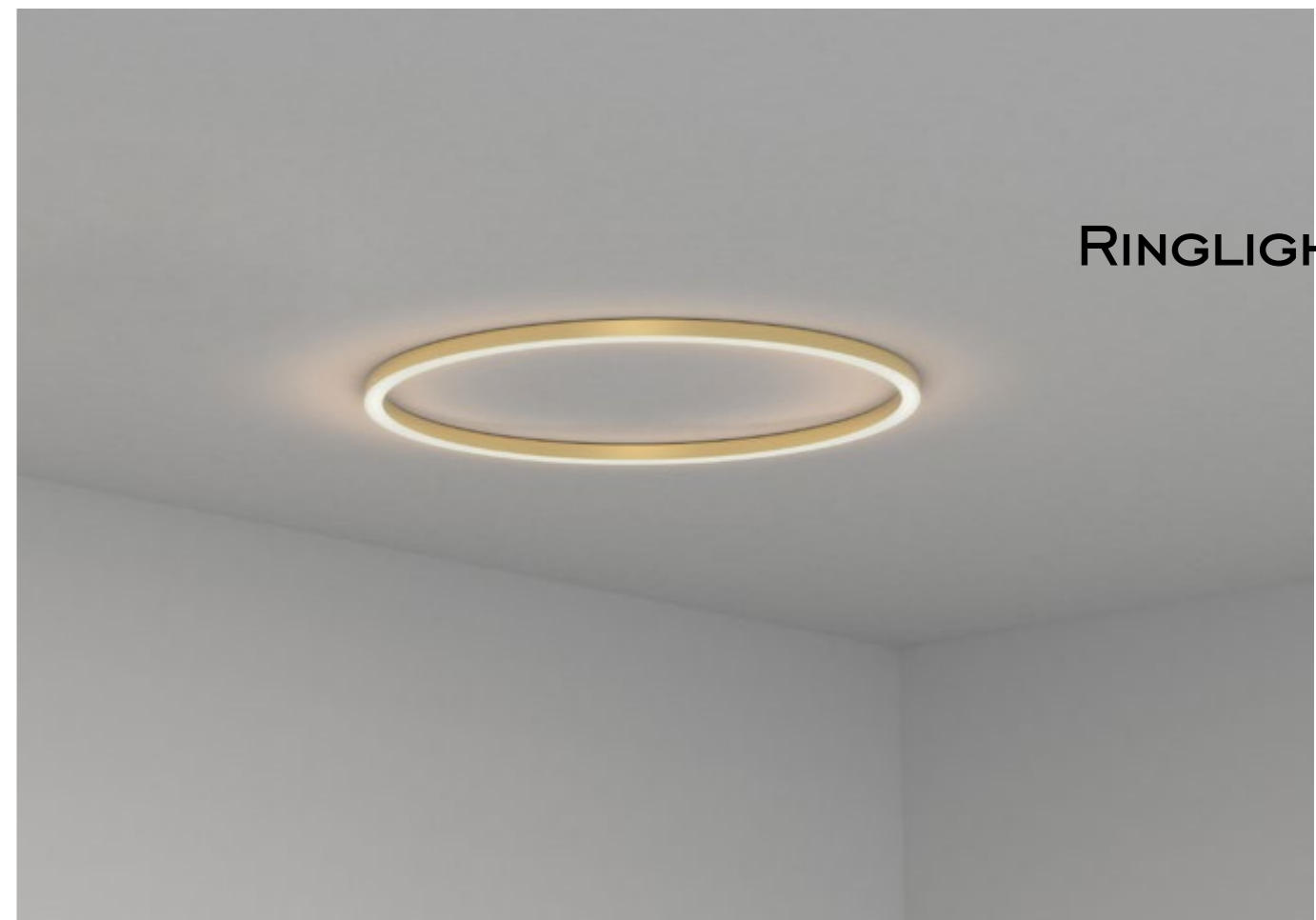

RINGLIGHT

Z99-D900-DOWN40

	650	900	1200	1500
	Z99-D650-	Z99-D900-	Z99-D1200-	Z99-D1500-
TECHNIK	TECHNIK	TECHNIK	TECHNIK	TECHNIK
25mm	LED 40W 2700K 2400lm	LED 55W 2700K 3400lm	LED 75W 2700K 4600lm	LED 95W 2700K 5700lm
40mm	LED 40W 2700K 2400lm	LED 55W 2700K 3400lm	LED 75W 2700K 4600lm	LED 95W 2700K 5700lm

DOWN25

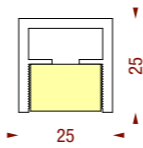

DOWN40

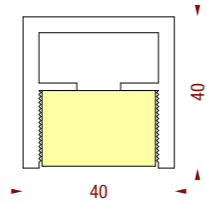

Andere Ausführungen auf Anfrage möglich.



Z99-D4674-600



CEILING

Z99-D4674-1000

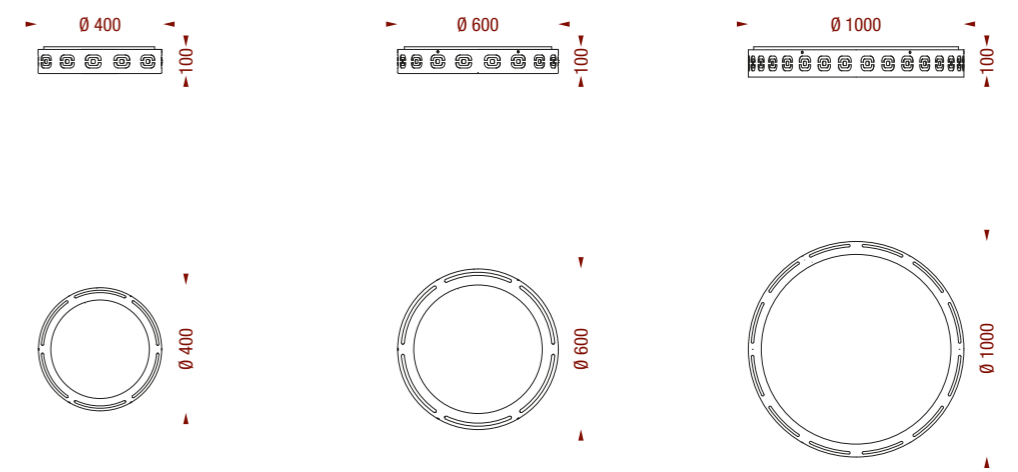

Z99-D4674-400

TECHNIK
LED 22W 3000K 1400lm

230 Volt IP 20 DALI D

Z99-D4674-600

TECHNIK
LED 45W 3000K 2700lm

230 Volt IP 20 DALI D

Z99-D4674-1000

TECHNIK
LED 110W 3000K • 7900lm

230 Volt IP 20 DALI D



CEILING

Z99-D1134-800

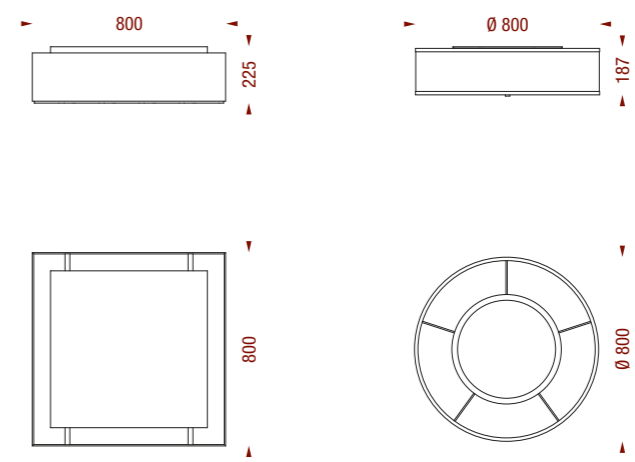

Z99-D1134-800

TECHNIK
4x E27

230 Volt IP 20

Z99-PL0-D4-180-1-E27
Z99-PL0-D4-180-1-LED

TECHNIK
4x E27 oder
LED 44W 2700K 2800lm CRI90 

230 Volt IP 20

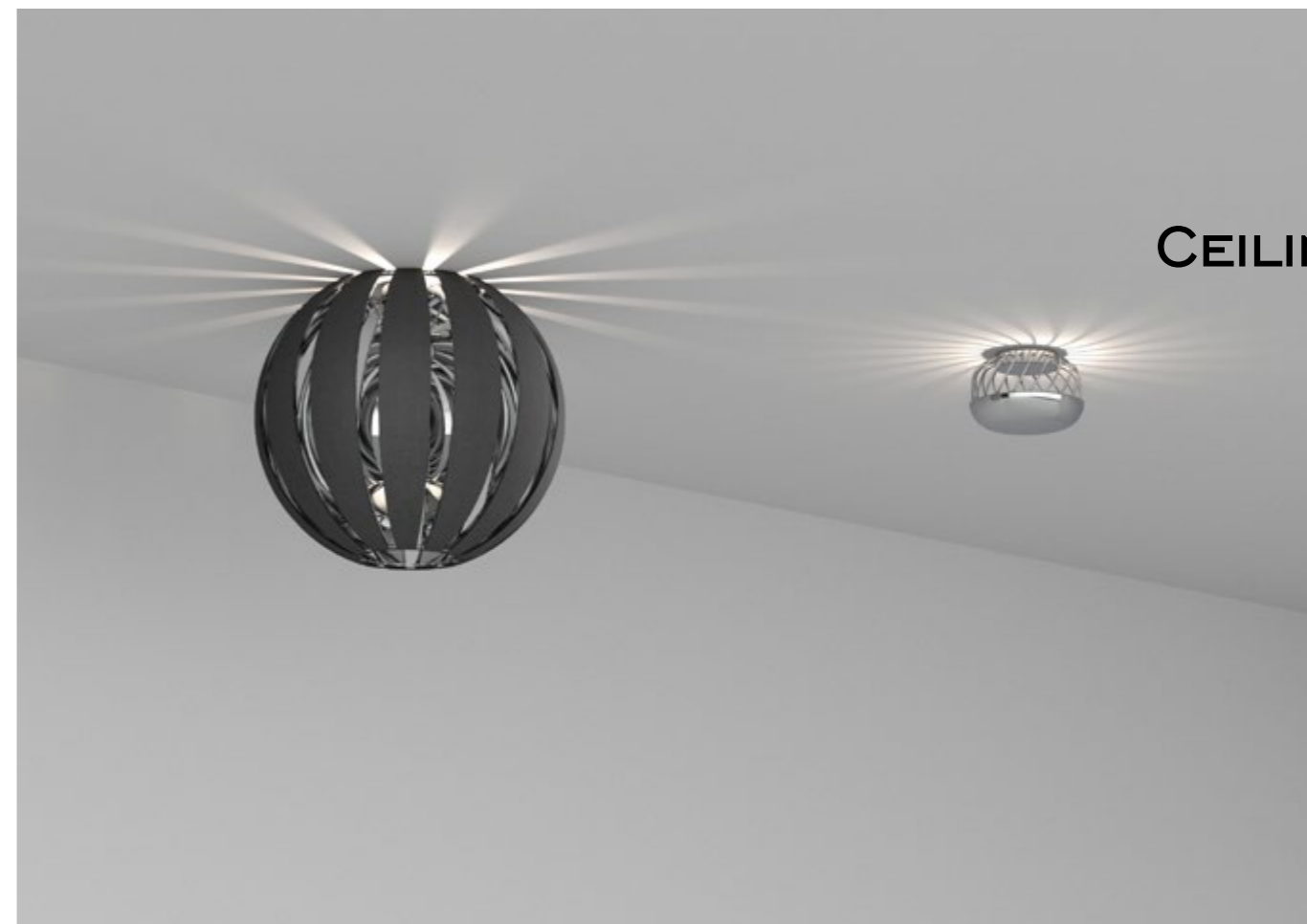

CEILING

Z99-W5643 • Z99-D4637-500

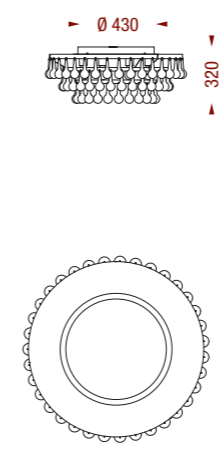

Z99-GRM2-600

TECHNIK
8x E27

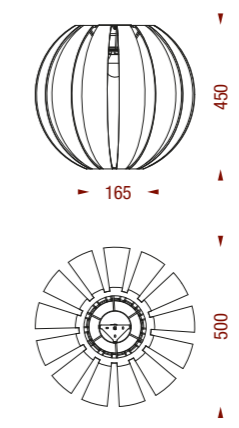

Z99-D4637-500

TECHNIK
1x E27

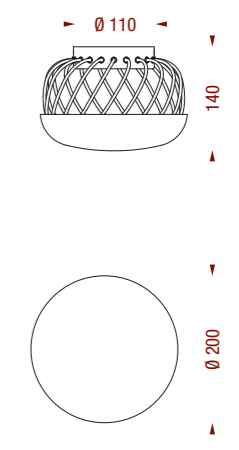
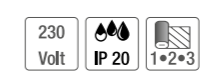

Z99-W5643

TECHNIK
LED 9W 2700K 700lm





Z99-D4698-4-870

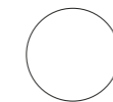
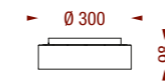

Z99-D4698-4-300

TECHNIK
LED 18W 3000K 1900lm

230 Volt IP 20 DALI D

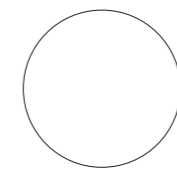
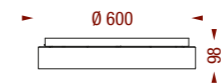

Z99-D4698-4-600

TECHNIK
LED 45W 3000K 5500lm

230 Volt IP 20 DALI D

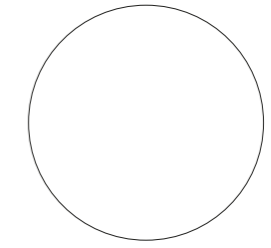
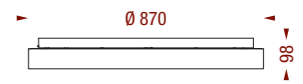

Z99-D4698-4-870

TECHNIK
LED 52W 3000K 7000lm

230 Volt IP 20 DALI D



CEILING

Z99-JUNO-DII

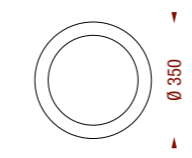
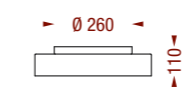

Z99-JUNO-DI

TECHNIK
LED 16W 3000K 2280lm

230 Volt IP 20 DALI D

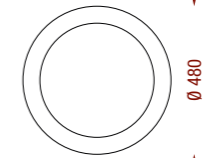
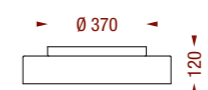

Z99-JUNO-DII

TECHNIK
LED 18W 3000K 2670lm

230 Volt IP 20 DALI D

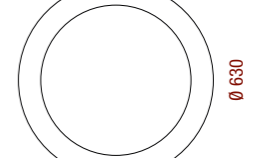

Z99-JUNO-DIII

TECHNIK
LED 17W 3000K 2780lm

230 Volt IP 20 DALI D



Z99-D1430-600
CASINO BERN • Bern



CEILING

Z99-D1430-260 • Z99-H3891

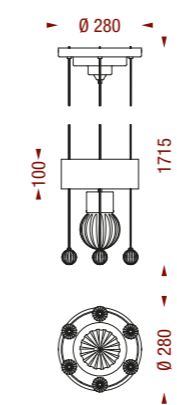

Z99-D1430-260

TECHNIK
1x E27

230 Volt IP 20



Z99-D1430-600

TECHNIK
5x E27

230 Volt IP 20

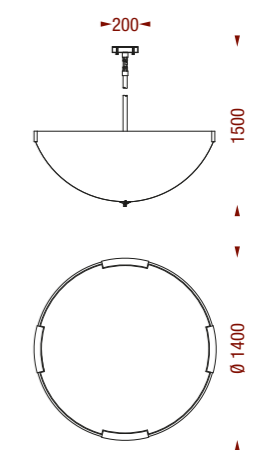

Z99-H3891

TECHNIK
12x E27

230 Volt IP 20

2F

Metalloberflächen: 1 • 2 • 4



CEILING

Z99-D0382-1

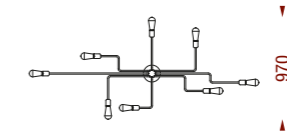
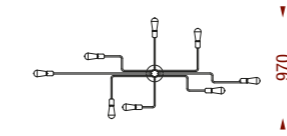
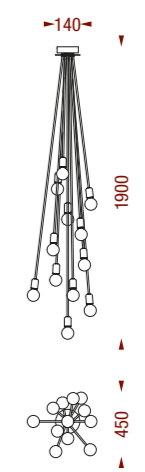
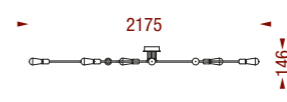
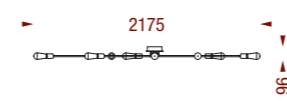

Z99-D0382

Z99-D0382-1

Z99-H1306-1985

TECHNIK
8x E27

TECHNIK
8x E27

TECHNIK
12x E27

230 Volt

230 Volt

230 Volt



CEILING

Z99-H4512-2300

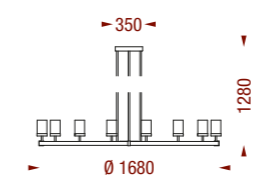

Z99-H4512-1680

TECHNIK
12x E27

230 Volt IP 20

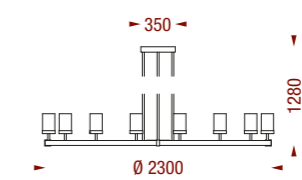

Z99-H4512-2300

TECHNIK
16x E27

230 Volt IP 20



Z99-D0612



CEILING

Z99-D0612

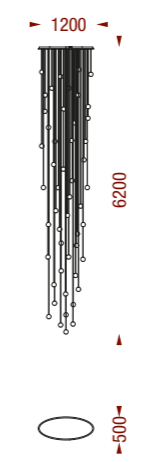

Z99-D0612

TECHNIK
50x LED á 2W 2700K á 200lm

230 Volt IP 20 DALI D

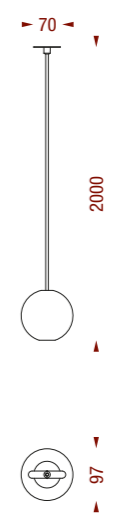

Z99-H0651

TECHNIK
1x G9

230 Volt IP 20



CEILING

Z99-H0328-4

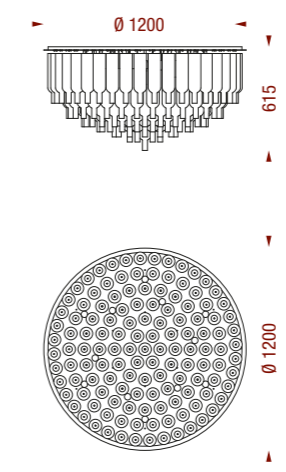

Z99-H0327-5-1200

TECHNIK
15x E14

230 Volt IP 20

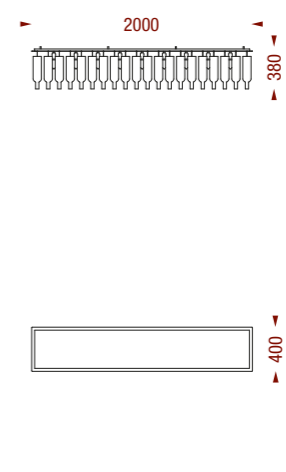

Z99-H0328-4

TECHNIK
9x E14

230 Volt IP 20

SUSPENSION





RINGLIGHT

Bestellbeispiel: Z99-H900-DOWN40

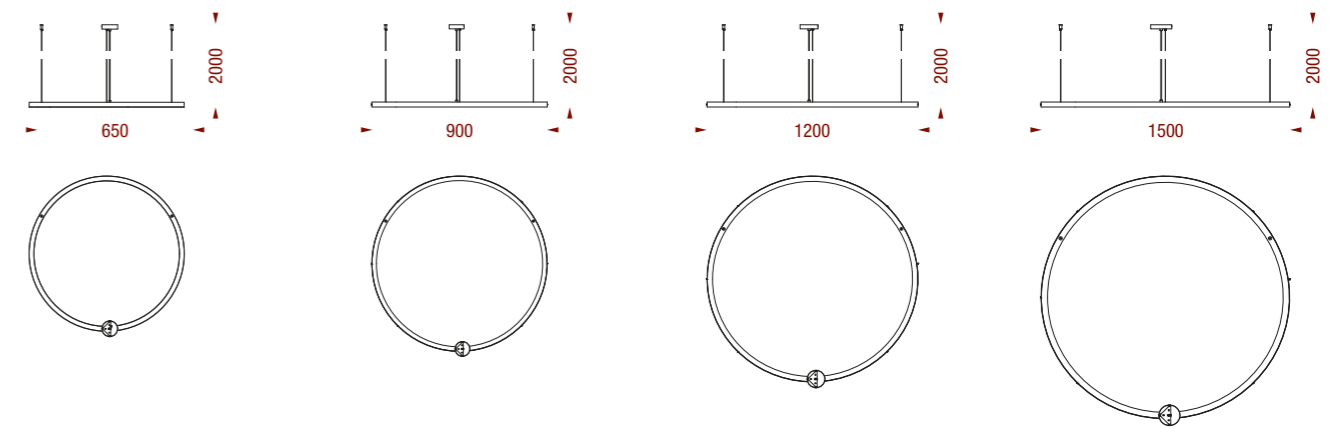
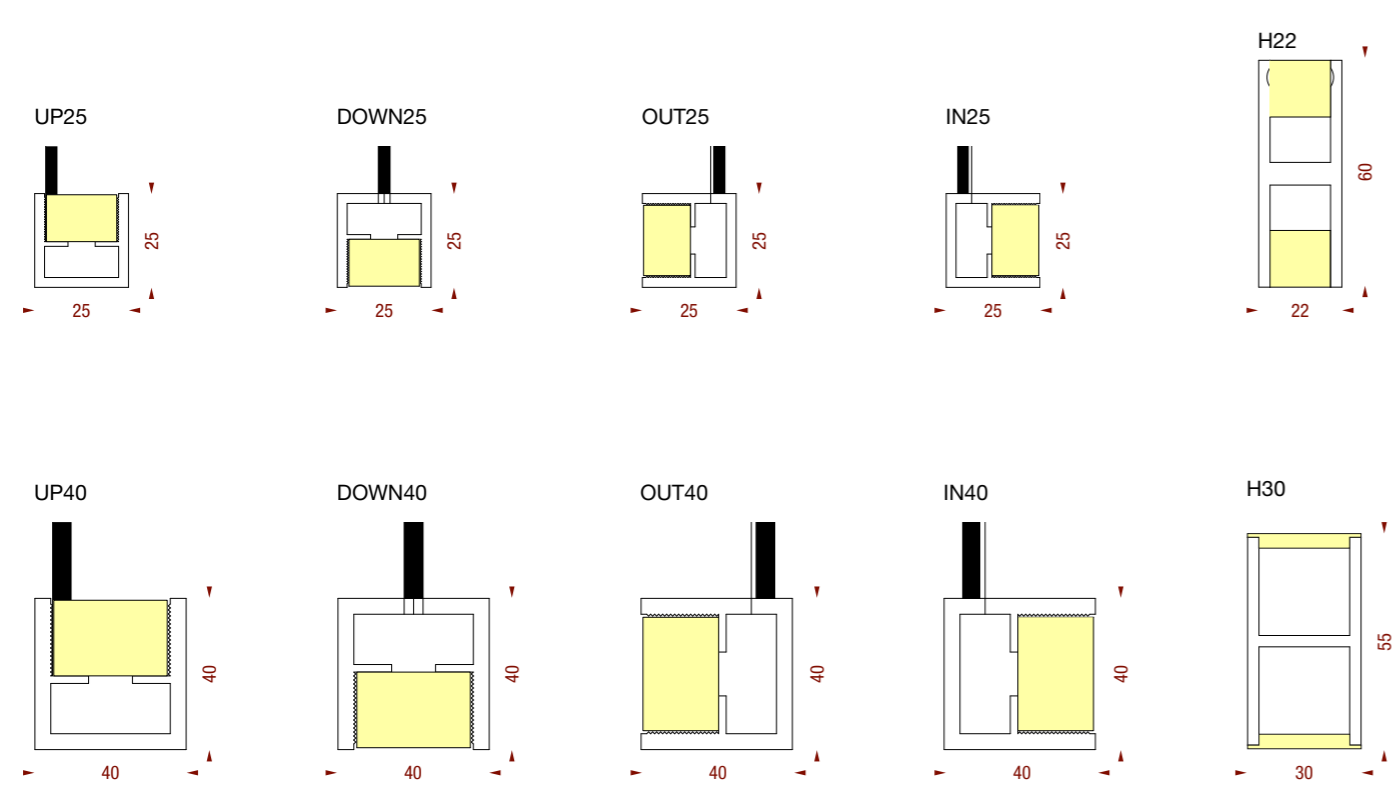

Z99-H650- Z99-H900- Z99-H1200- Z99-H1500-

	TECHNIK		TECHNIK		TECHNIK		TECHNIK			
25mm	LED 40W 2700K 2400lm		LED 55W 2700K 3400lm		LED 75W 2700K 4600lm		LED 95W 2700K 5700lm			
40mm	LED 40W 2700K 2400lm		LED 55W 2700K 3400lm		LED 75W 2700K 4600lm		LED 95W 2700K 5700lm			
H22	2x LED 30W 2700K 1400lm		2x LED 43W 2700K 1900lm		2x LED 60W 2700K 2600lm		2x LED 70W 2700K 3250lm			
H30	2x LED 24W 2700K 2200lm		2x LED 35W 2700K 3000lm		2x LED 45W 2700K 4000lm		2x LED 58W 2700K 5000lm			
	24 Volt		DALI	D	extern	24 Volt		DALI	D	extern



SUSPENSION

Z99-H1312-1-600

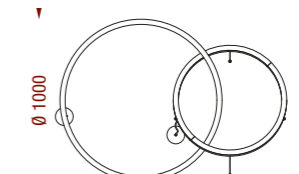
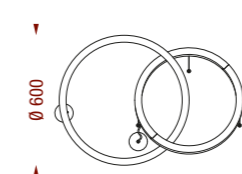
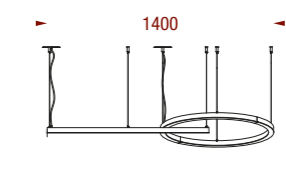
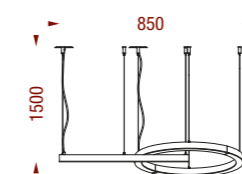

Z99-H1312-1-600

Z99-H1312-1-1000

TECHNIK

LED 40W 2700K 3000lm

TECHNIK

LED 65W 2700K 5000lm



Z99-H1312-1-1000

HOTEL ALPENHOF • Filzmoos



Metalloberflächen: 1 • 2 • 4



Z99-H4469
GRAND HOTEL WALLISERHOF • Saas-Fee



SUSPENSION

Z99-H1582



Z99-H1469-900
SCHLOSS MARBACH • Marbach

© Tagungs- und Seminarzentrum Schloss Marbach GmbH

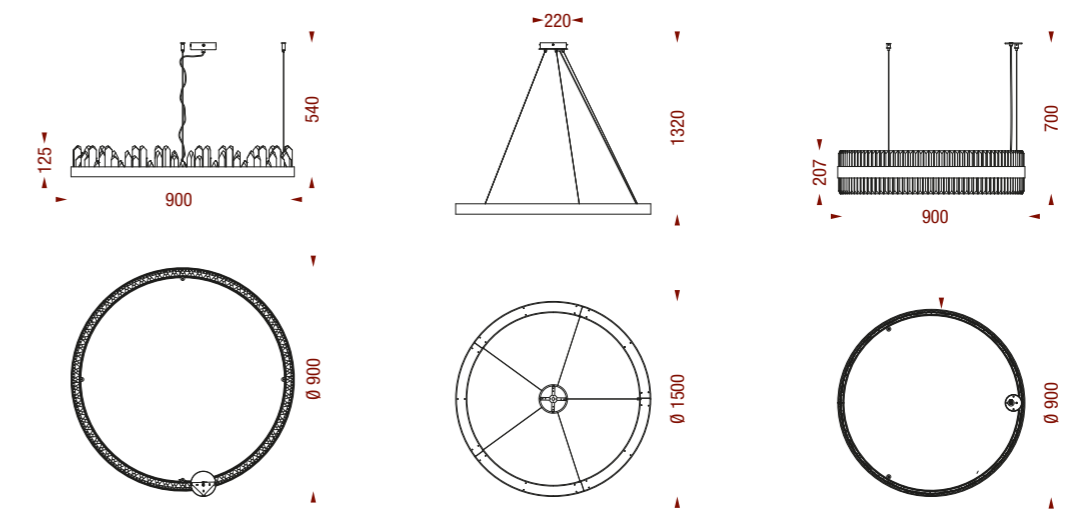

Z99-H4469

Z99-H1582

Z99-H1469-900

TECHNIK

LED 80W 2700K 6000lm

TECHNIK

9x LED à 9W 2700K 800lm
LED 65W 2700K 5000lm

TECHNIK

LED 80W 3100/4300lm
2200K / 5000K - Tunable white



Metalloberflächen: 1 • 2 • 4



SUSPENSION

Z99-H5443

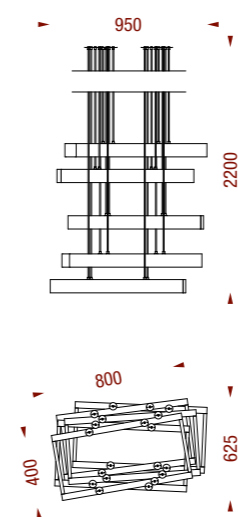

Z99-H2046

TECHNIK

5x LED á 15W 2700K 1400lm

24 Volt IP 20 DALI D extern

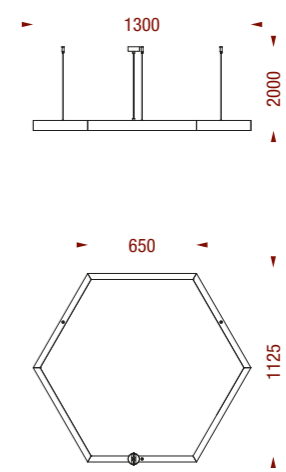

Z99-H5443

TECHNIK

LED 80W 2700K 7000lm

24 Volt IP 20 DALI D extern



SUSPENSION

Z99-H0767 • Z99-H5410-1

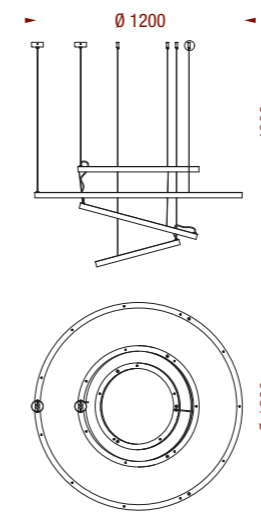

Z99-H0918-2

TECHNIK
LED 110W 2700K 10000lm

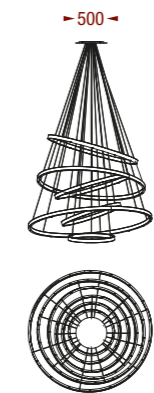

Z99-H5410-1

TECHNIK
LED 700W 2700K 60000lm

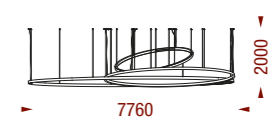

Z99-H0767

TECHNIK
LED 1900W 2700K Im

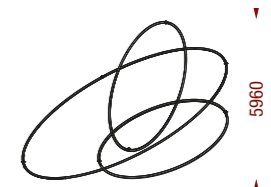



SUSPENSION

Z99-H1403-1

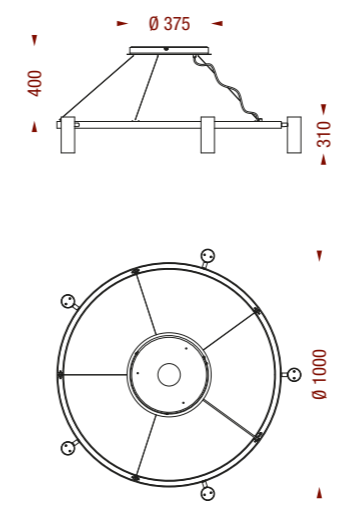

Z99-H1403-1

TECHNIK
5x GU10

230 Volt IP 20

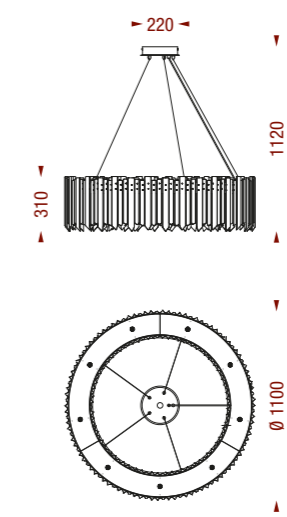

Z99-H0693-1100

TECHNIK
9x LED á 4,2W 460lm/580lm
2200K / 5000K - Tunable white

230 Volt IP 20 DALI D

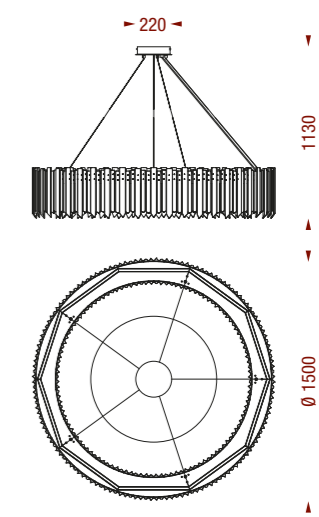

Z99-H0693-1500

TECHNIK
9x LED á 4,2W 460lm/580lm
2200K / 5000K - Tunable white

230 Volt IP 20 DALI D



SUSPENSION

Z99-H0779 • Z99-H0706

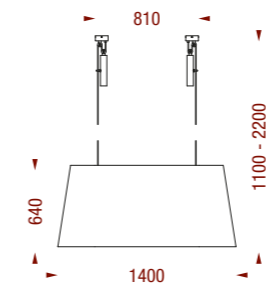

Z99-H0706

TECHNIK
4x E27

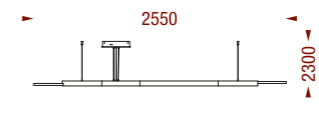

Z99-H0778

TECHNIK
3x LED á 19W 3000K 3000lm
LED 75W 3000K 7500lm

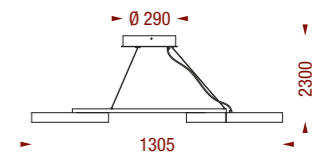

Z99-H0779

TECHNIK
2x LED á 19W 3000K 3000lm

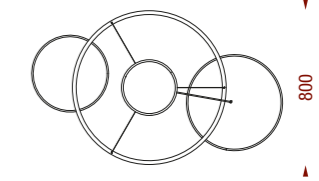
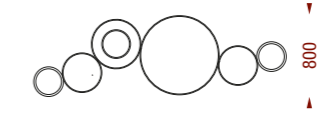
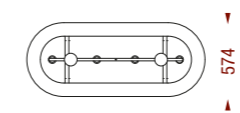



Z99-H1462-1
HOTEL INDIGO • Dresden



SUSPENSION

Z99-H5743

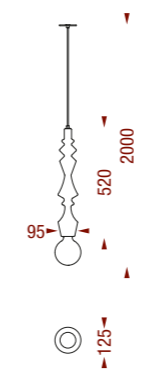

Z99-H1462-1

TECHNIK
1x E27

230 Volt

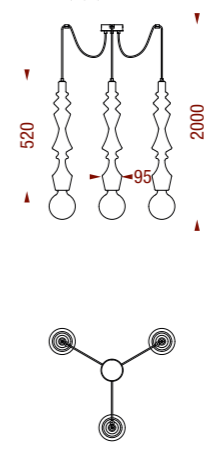

Z99-H1462-3

TECHNIK
3x E27

230 Volt

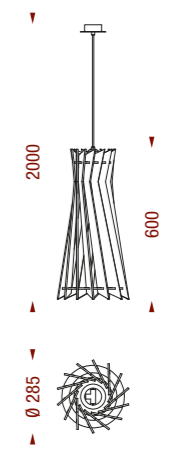

Z99-H5743

TECHNIK
1x E27

230 Volt



SUSPENSION

Z99-H1496 • Z99-H1495 • Z99-H1497

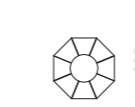
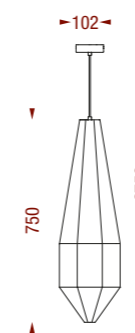

Z99-H1496

TECHNIK

2x LED á 8W 2700K 680lm 700mA

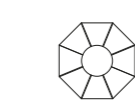
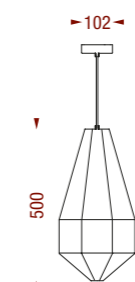

Z99-H1495

TECHNIK

2x LED á 8W 2700K 680lm 700mA

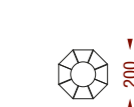
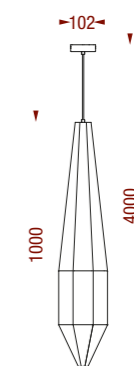

Z99-H1497

TECHNIK

2x LED á 8W 2700K 680lm 700mA





SUSPENSION

Z99-H0943-1000 • Z99-H0943-2300

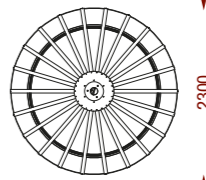
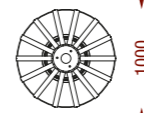
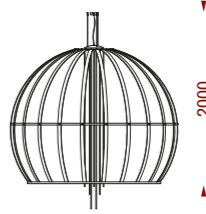
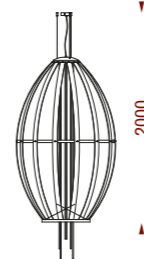

Z99-H0943-1000

Z99-H0943-2300

TECHNIK
LED 40W 2700K 3000lm

TECHNIK
LED 150W 2700K 12000lm

230 Volt IP 20 DALI D

230 Volt IP 20 DALI D

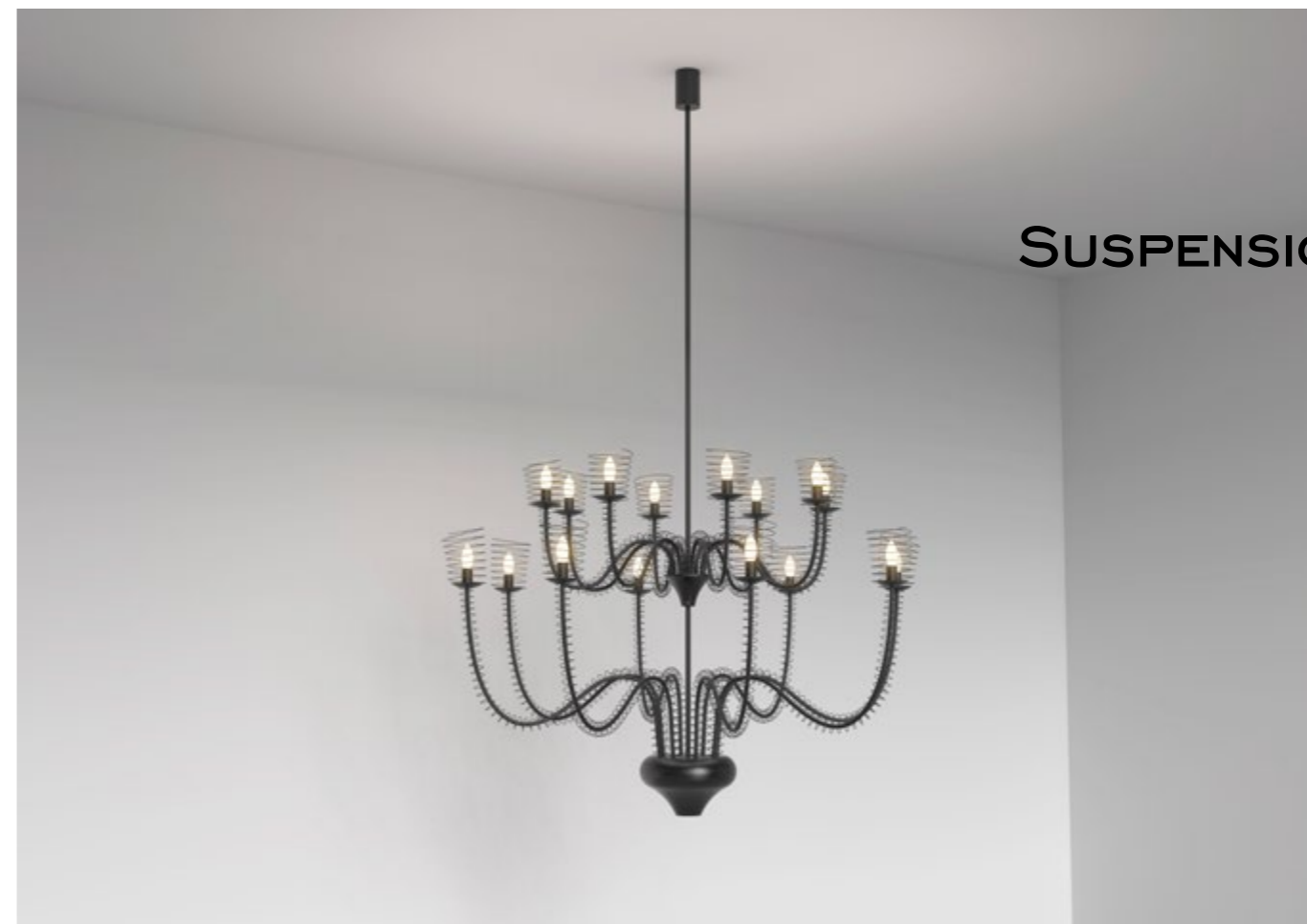

SUSPENSION

Z99-H1304

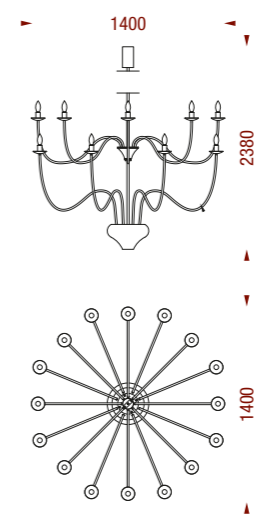

Z99-H1304

TECHNIK

16x E14
1x GU10

230 Volt  IP 20

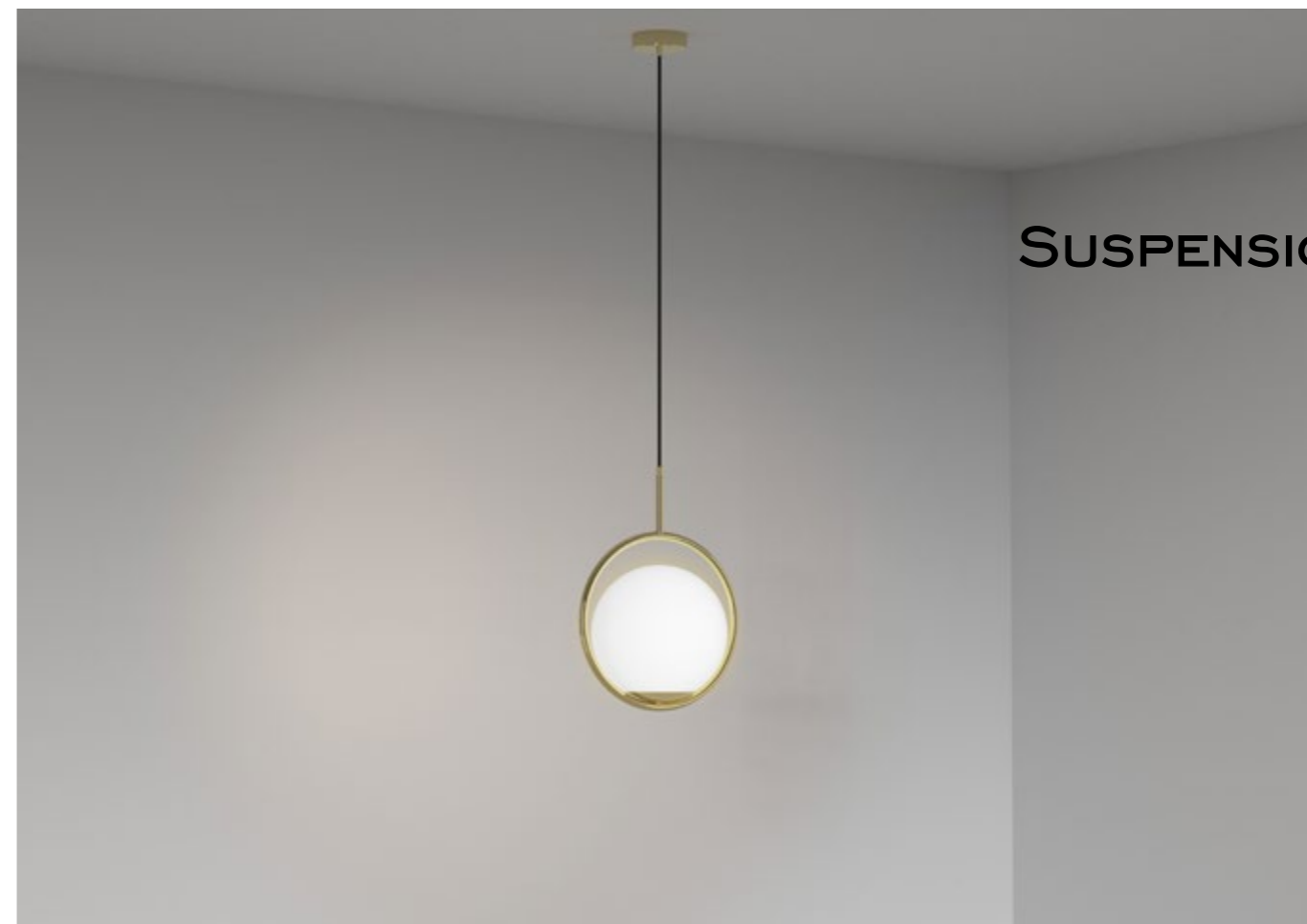

SUSPENSION

Z99-HOL-H1

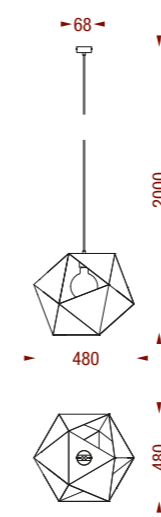

Z99-H1485

TECHNIK
1x E27

230 Volt IP 20

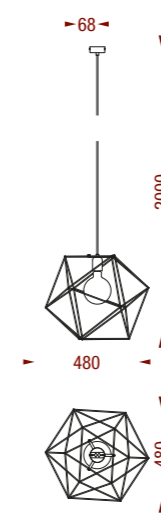

Z99-H1486

TECHNIK
1x E27

230 Volt IP 20

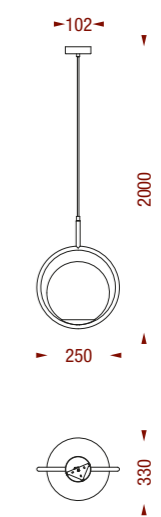

Z99-HOL-H1

TECHNIK
1x E14

230 Volt IP 20



SUSPENSION

Z99-H0972 • Z99-H0728-1-300 • Z99-H0728-1-400 • Z99-H0728-1-550

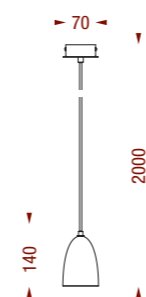

Z99-H0972

TECHNIK
1x G9

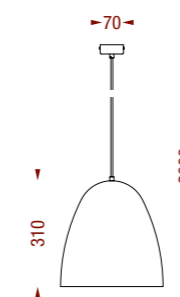
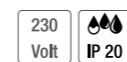

Z99-H0728-1-300

TECHNIK
1x E27

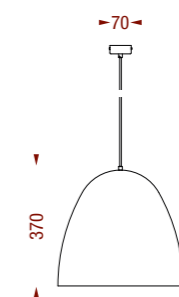

Z99-H0728-1-400

TECHNIK
1x E27

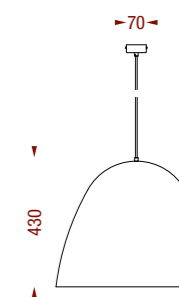

Z99-H0728-1-550

TECHNIK
2x E27





SUSPENSION

Z99-H5787 • Z99-H5786 • Z99-H5785

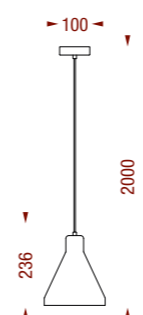

Z99-H5787

TECHNIK
1x E27

230 Volt IP 20

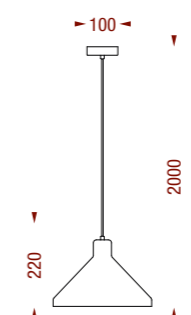

Z99-H5786

TECHNIK
1x E27

230 Volt IP 20

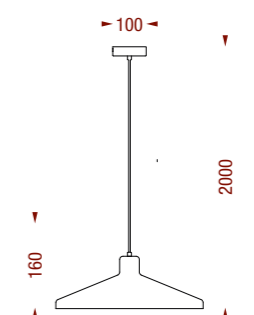

Z99-H5785

TECHNIK
1x E27

230 Volt IP 20

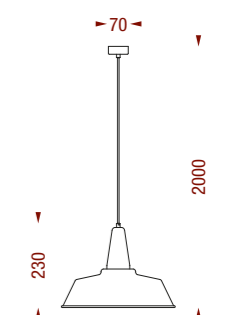

Z99-H1432-1

TECHNIK
1x E27

230 Volt IP 20



Z99-H0647
TANK & RAST • Fürholzen West



Z99-H0647-12 • Z99-H0647-10

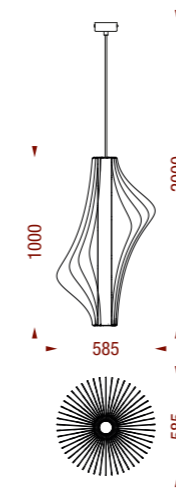

Z99-H0647-10

TECHNIK
1x E27

230 Volt IP 20

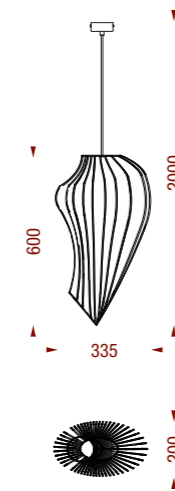

Z99-H0647-11

TECHNIK
1x E27

230 Volt IP 20

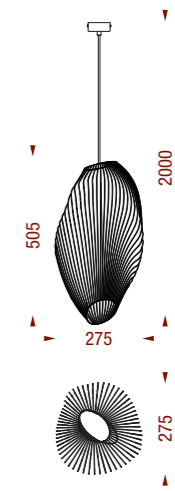

Z99-H0647-12

TECHNIK
1x E27

230 Volt IP 20

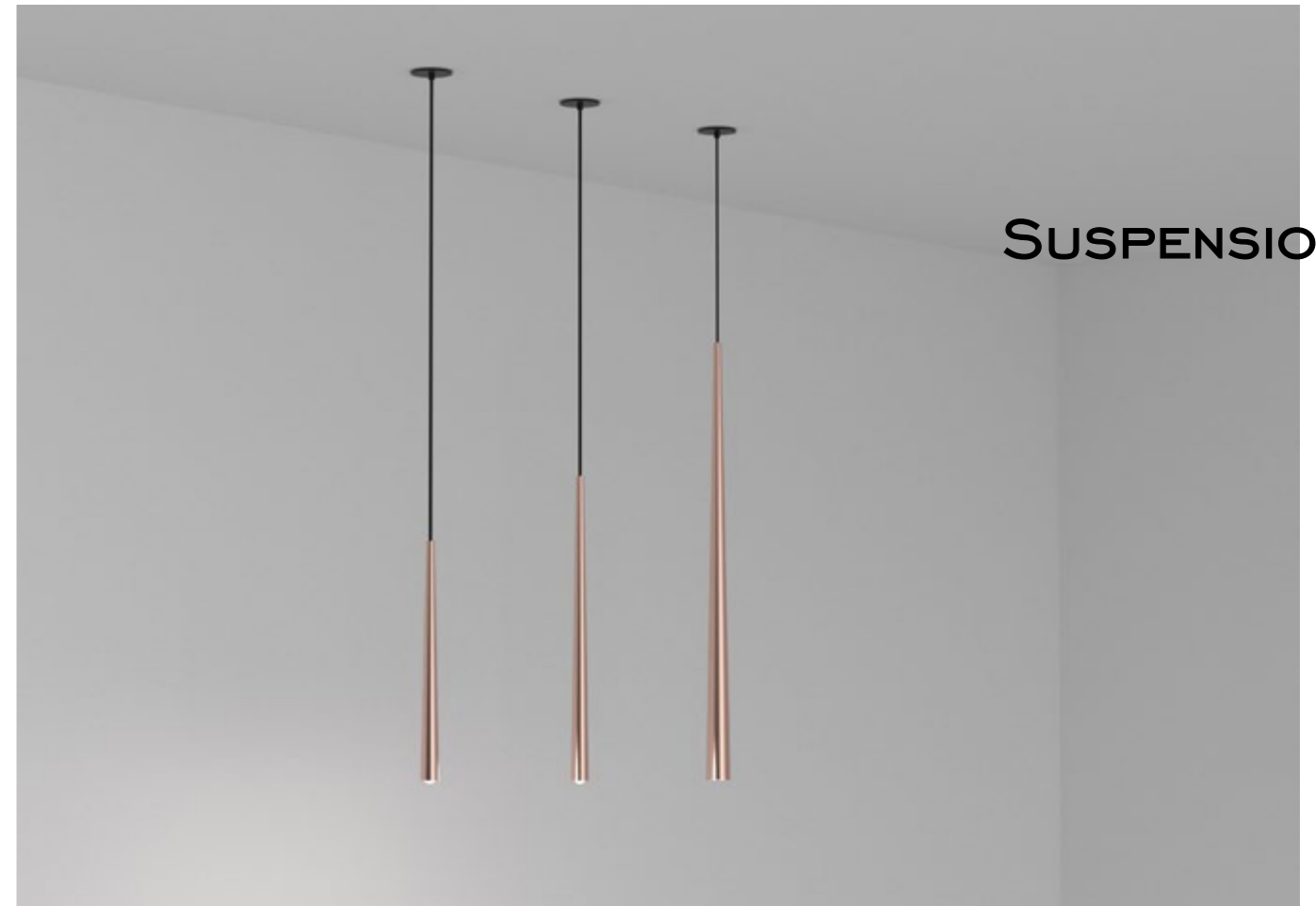

Z99-H0796-1100-2 • Z99-H0796-1100 • Z99-H0796

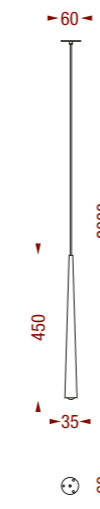

Z99-H0796-1100-2

TECHNIK
LED 2W 2700K 160lm 500mA

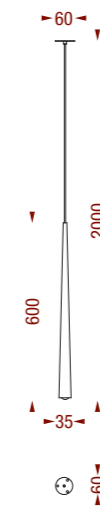

Z99-H0796-1100

TECHNIK
LED 2W 2700K 160lm 500mA

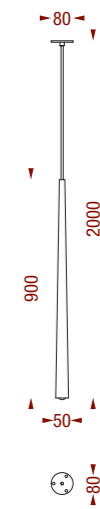

Z99-H0796

TECHNIK
LED 10W 2700K 900lm 350mA

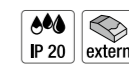



SUSPENSION

Z99-H0400

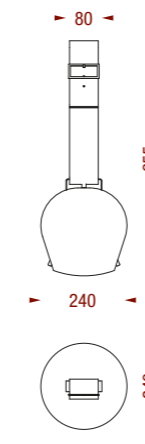

Z99-H0400

TECHNIK
1x 8W LED 2700K 620lm

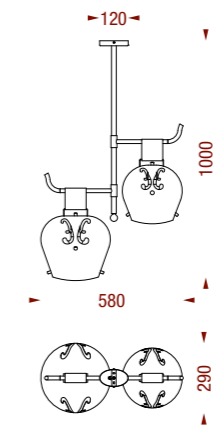

Z99-H0354-2

TECHNIK
2x E27

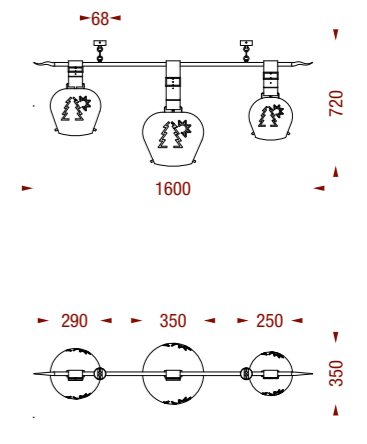

Z99-H0354-10

TECHNIK
3x E27





SUSPENSION

Z99-VIN-H2 • Z99-VIN-H3 • Z99-VIN-H1

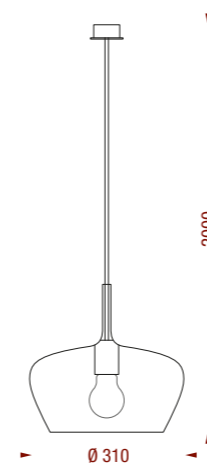

Z99-VIN-H1

TECHNIK
1x E27

230 Volt IP 20

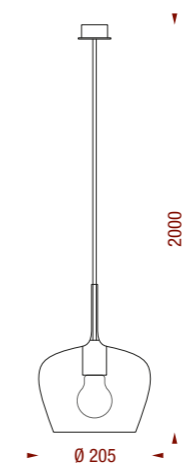

Z99-VIN-H2

TECHNIK
1x E27

230 Volt IP 20

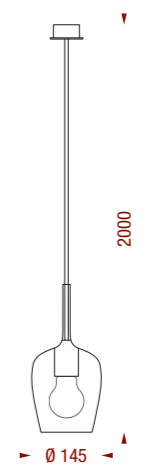

Z99-VIN-H3

TECHNIK
1x E27

230 Volt IP 20

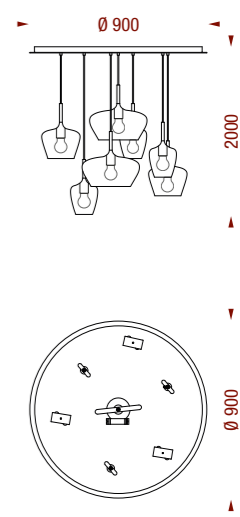

Z99-VIN-H7

TECHNIK
7x E27

230 Volt IP 20



SUSPENSION

Z99-D4719



Z99-H1310

TECHNIK

3x LED á 2W 2700K 160lm

230 Volt IP 20

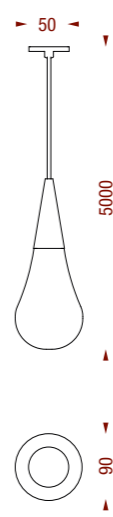

Z99-H1310-1

TECHNIK

LED á 2W 2700K 160lm

24 Volt IP 20 extern

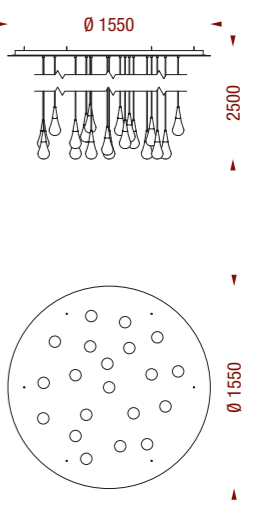

Z99-D4719

TECHNIK

20x LED á 2W 2700K 160lm

230 Volt IP 20



Z99-H0416



SUSPENSION

Z99-H0416

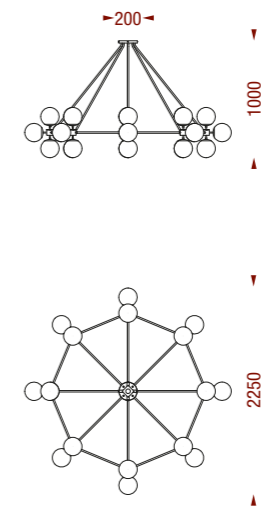

Z99-H0416

TECHNIK
24x E27

230 Volt  IP 20

2F Metalloberflächen: 1 • 2 • 4



CEILING

Z99-H1530

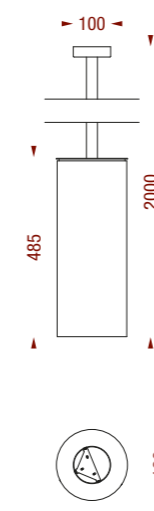

Z99-H1530

TECHNIK
1x E27

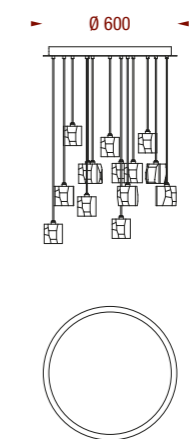

Z99-D0359-1-600

TECHNIK
18x LED à 2W 2700K à 200lm





SUSPENSION

Z99-H0762-6-2 • Z99-H4482

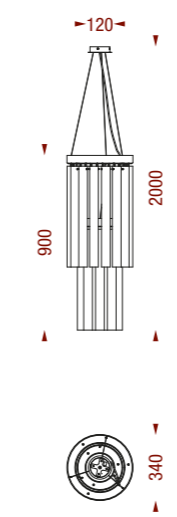

Z99-H0762-6-2

TECHNIK
24x E27

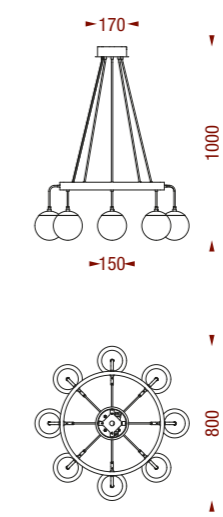

Z99-H4482

TECHNIK
8x E14

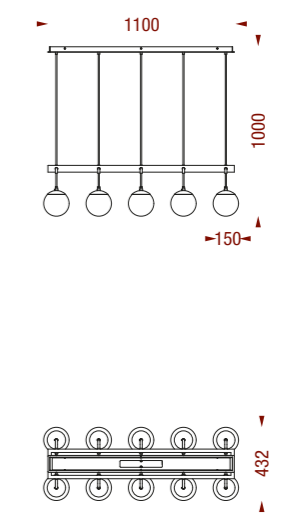
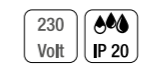

Z99-H4484

TECHNIK
10x E14



ANGLE





Z99-ANG-S1 • Z99-ANG-T1



ANGLE

Z99-ANG-W1 • Z99-ANG-D1

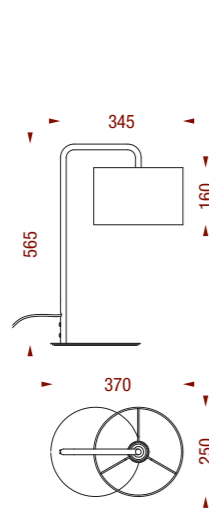

Z99-ANG-T1

TECHNIK
1x E27

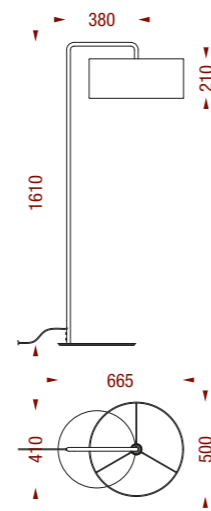

Z99-ANG-S1

TECHNIK
1x E27

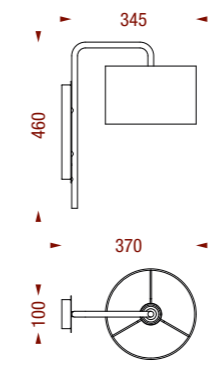

Z99-ANG-W1

TECHNIK
1x E27

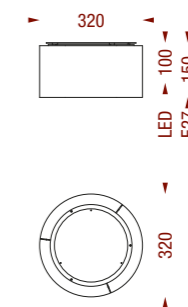

Z99-ANG-D1

TECHNIK
2x E27 oder
LED 10W 2700K 1400lm CRI90 DALI-D



BUCKET





Z99-PBU-T2



BUCKET

Z99-PBU-S1

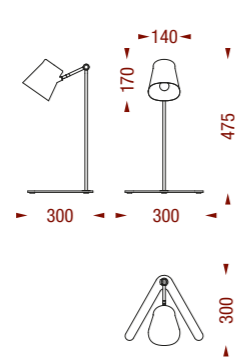

Z99-PBU-T1

TECHNIK
1x E27

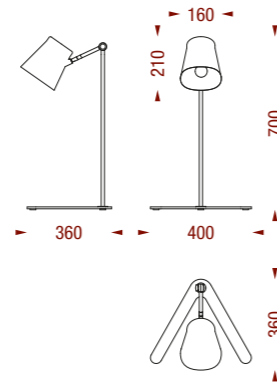

Z99-PBU-T2

TECHNIK
1x E27

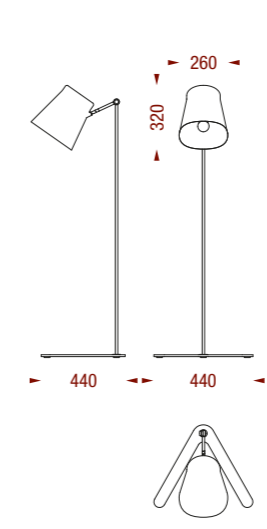

Z99-PBU-S1

TECHNIK
1x E27

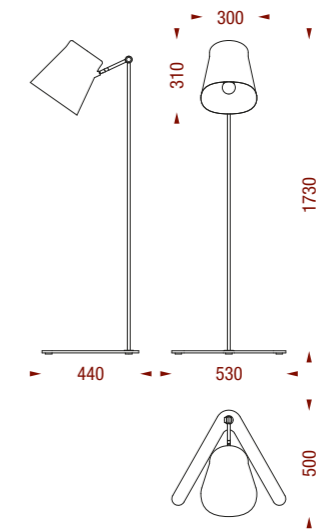

Z99-PBU-S1-6

TECHNIK
1x E27





BUCKET



Z99-PBU-H1 • Z99-PBU-W1

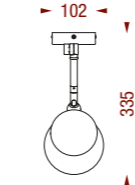
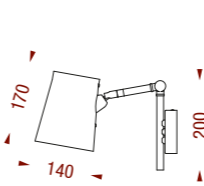

Z99-PBU-W1

TECHNIK
1x E27 max. 40W

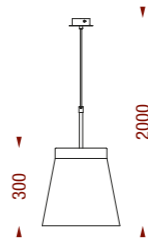

Z99-PBU-H1

TECHNIK
1x E27 max. 60W

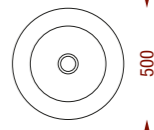
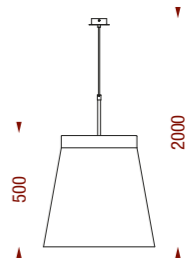

Z99-PBU-H2

TECHNIK
1x E27 max. 60W



COMBI





Z99-PCO-T1



COMBI

Z99-PCO-W1-3

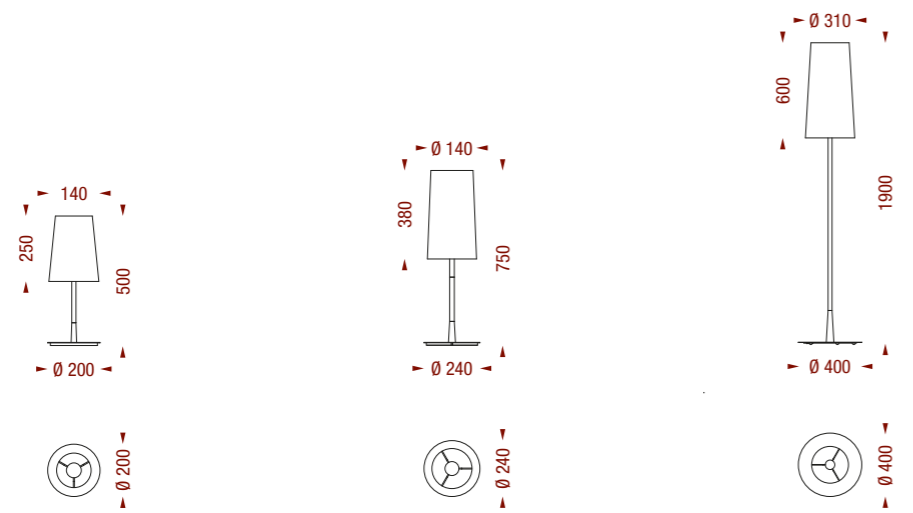

Z99-PCO-T1

Z99-PCO-T2

Z99-PCO-S1

TECHNIK

1x E27

TECHNIK

1x E27

TECHNIK

1x E27

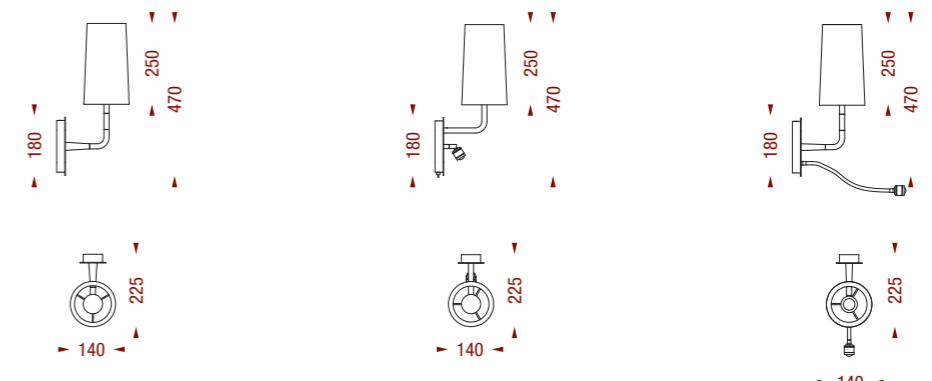

Z99-PCO-W1

Z99-PCO-W1-2

Z99-PCO-W1-3

TECHNIK

1x E27

TECHNIK

1x E27
+LED 2W 2700K 160lm CRI 90

TECHNIK

1x E27
+LED 2W 2700K 160lm CRI 90



2F

Metalloberflächen: 1 • 2 • 3 • 4
Stoffoberflächen: 1 • 2 • 3



COMBI

Z99-PCO-W2

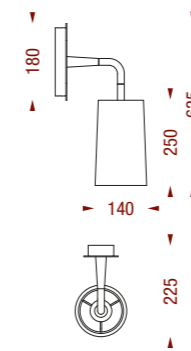

Z99-PCO-W2

TECHNIK
1x E27

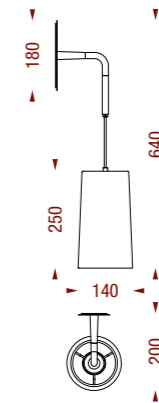

Z99-PCO-W2-EINBAU

TECHNIK
1x E27





Z99-PCO-H2



COMBI

Z99-PCO-D3

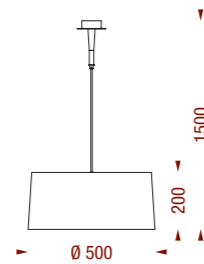

Z99-PCO-H1

TECHNIK
1x E27

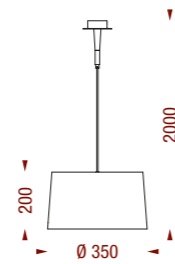

Z99-PCO-H2

TECHNIK
1x E27

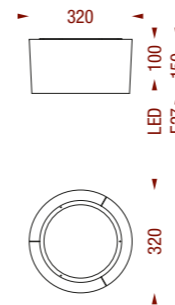

Z99-PCO-D1-E27
Z99-PCO-D1-LED

TECHNIK
2x E27 oder

LED 10W 2700K 1400lm CRI90

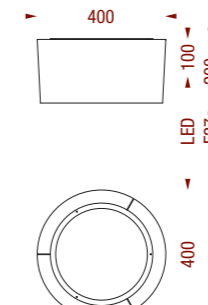

Z99-PCO-D2-E27
Z99-PCO-D2-LED

TECHNIK
2x E27 oder

LED 10W 2700K 1400lm CRI90

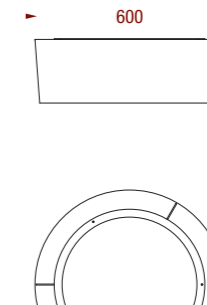

Z99-PCO-D3-E27
Z99-PCO-D3-LED

TECHNIK
3x E27 oder

LED 28W 2700K 1800lm CRI90

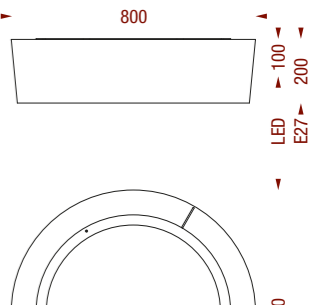

Z99-PCO-D4-E27
Z99-PCO-D4-LED

TECHNIK
4x E27 oder

LED 44W 2700K 2800lm CRI90



CURLING





Z99-CUR-T1 • Z99-CUR-S1



CURLING

Z99-CUR-W2 • Z99-CUR-H3

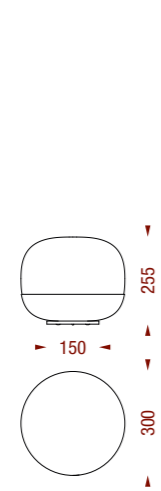

Z99-CUR-T1

TECHNIK
1x E27



Z99-CUR-S1

TECHNIK
1x E27



Z99-CUR-W2

TECHNIK
1x E27

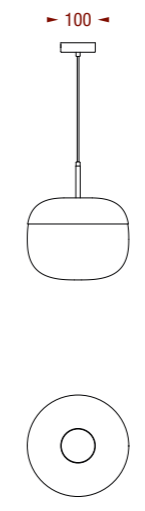

Z99-CUR-H1

TECHNIK
1x E27

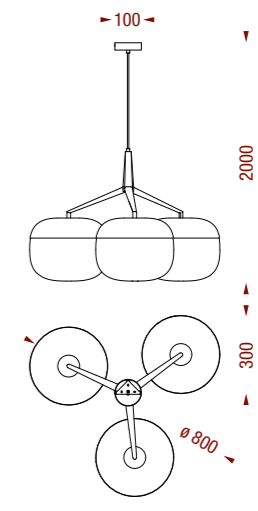

Z99-CUR-H3

TECHNIK
1x E27



DEER





Z99-DEE-W2



DEER

Z99-DEE-H6

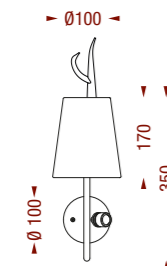

Z99-DEE-W1-R
(Leseleuchte rechts)

TECHNIK

1x E14
+LED 2W 2700K 160lm CRI 90

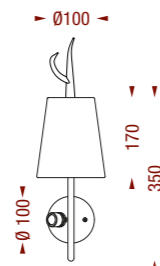

Z99-DEE-W1-L
(Leseleuchte links)

TECHNIK

1x E14
+LED 2W 2700K 160lm CRI 90

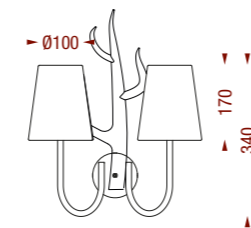

Z99-DEE-W2

TECHNIK

2x E14

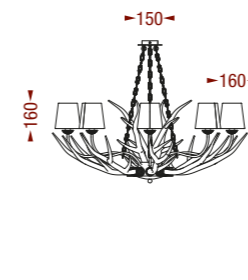

Z99-DEE-H8

TECHNIK

8x E14

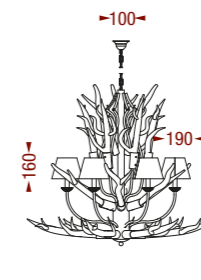
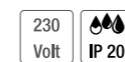

Z99-DEE-H6-1

TECHNIK

6x E14

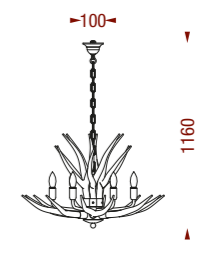
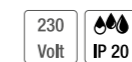

Z99-DEE-H6

TECHNIK

6x E14



2F

Metalloberflächen: 1 • 2 • 4
Stoffoberflächen: 1 • 2 • 3

ECLIPSE





Z99-ECL-T1 • Z99-ECL-S1



ECLIPSE

Z99-ECL-W1 • Z99-ECL-D1

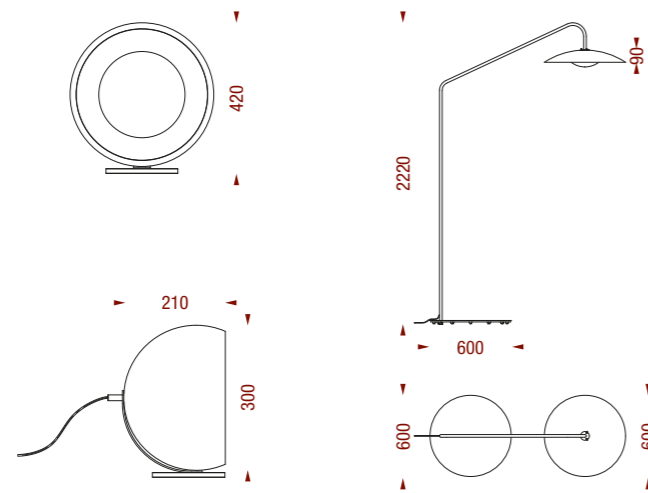

Z99-ECL-T1

Z99-ECL-S1

TECHNIK
1x E27

TECHNIK
LED 7W 2700K 1200lm CRI 90

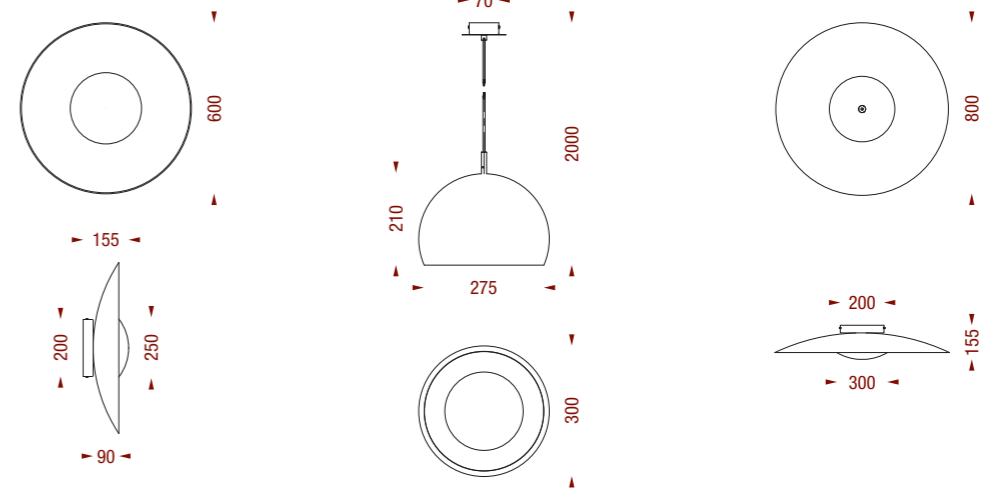

Z99-ECL-W1

Z99-ECL-H1

Z99-ECL-D1

TECHNIK
LED 7W 2700K 1200lm CRI 90

TECHNIK
1x E27

TECHNIK
LED 7W 2700K 1200lm CRI 90

LED 8W 2700K 700lm CRI 90



ELEGANCE



Z99-PEL-S1 • LED-2-FL-300-D1-A • Z99-PEL-D2 • Z99-PEL-T1

ALPENHOF • Zauchensee

© Foto Atelier Wolkerdorfer



Z99-PEL-S1 • Z99-PEL-T1



Z99-PEL-H3 • Z99PEL-W1-2

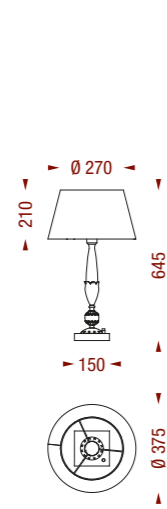

Z99-PEL-T1

TECHNIK
1x E27

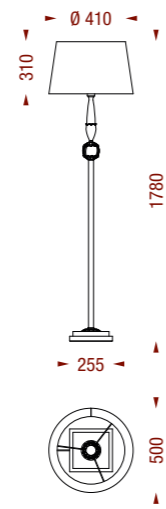

Z99-PEL-S1

TECHNIK
1x E27

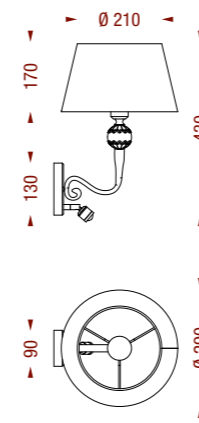

Z99-PEL-W1-2

TECHNIK
1x E27
+LED 2W 2700K 160lm CRI 90

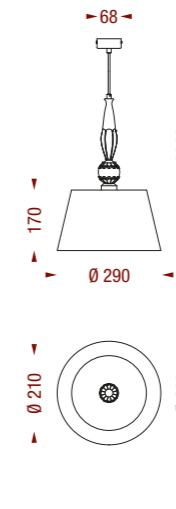

Z99-PEL-H3

TECHNIK
1x E27

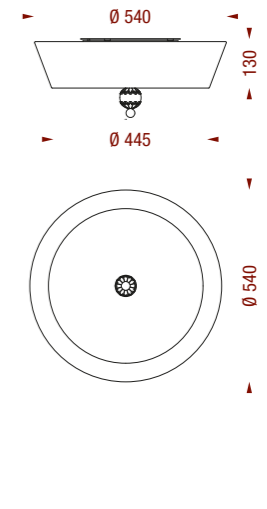

Z99-PEL-D2-E27
Z99-PEL-D2-LED

TECHNIK
2x E27 oder
LED 28W 2700K 1800lm CRI90



GLOBE





Z99-GLO-D1



GLOBE

Z99-GLO-S1 • Z99-GLO-W1

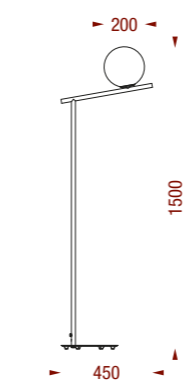

Z99-GLO-S1

TECHNIK
1x E27

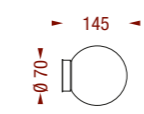

Z99-GLO-W1

TECHNIK
1x G9

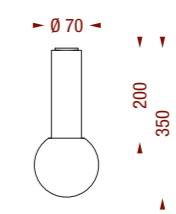
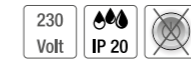

Z99-GLO-D1

TECHNIK
1x E27 oder

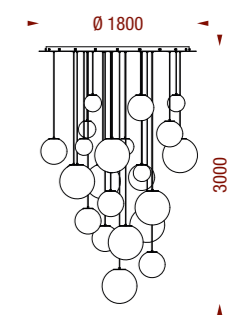

Z99-GLO-H1

TECHNIK
24x LED 4W 2700K à 450lm CRI 90

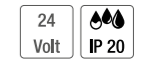

LED 8W 2700K 630lm CRI 90

2F

Metalloberflächen: 1 • 2 • 3 • 4

GRATE





Z99-GRA-S1 • Z99-GRA-W1



GRATE

Z99-GRA-H1 • Z99-GRA-H2

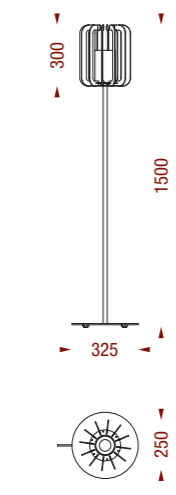

Z99-GRA-S1

TECHNIK
1x E27

230 Volt

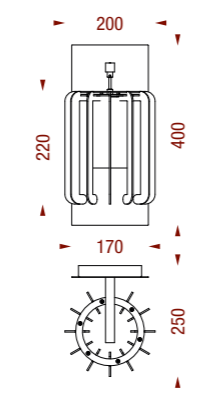

Z99-GRA-W1

TECHNIK
1 x E27

230 Volt

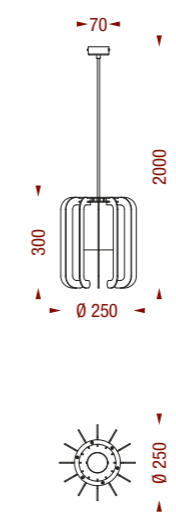

Z99-GRA-H1

TECHNIK
1x E27

230 Volt

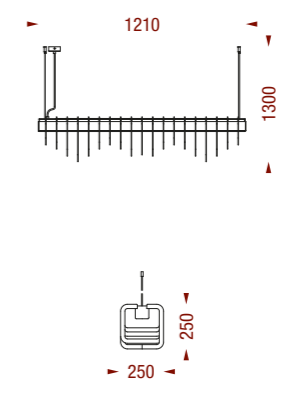

Z99-GRA-H2

TECHNIK
LED 9W 2700K 980lm CRI 90
LED 20W 2700K 2000lm CRI 90

230 Volt

HAMBURG





Z99-PHA-T1



Z99-PHA-W1-2

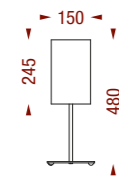

Z99-PHA-T1

TECHNIK
1x E27

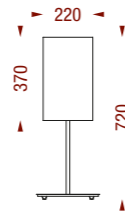

Z99-PHA-T2

TECHNIK
1x E27

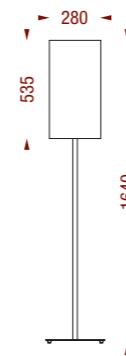

Z99-PHA-S1

TECHNIK
1x E27

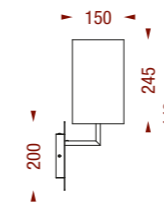

Z99-PHA-W1

TECHNIK
1x E27

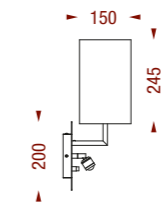

Z99-PHA-W1-2

TECHNIK
1x E27
+LED 2W 2700K 160lm CRI 90

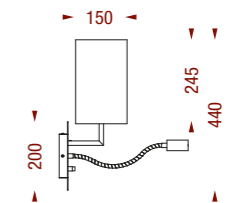

Z99-PHA-W1-3

TECHNIK
1x E27
+LED 2W 2700K 160lm CRI 90





HAMBURG

Z99-PHA-D4

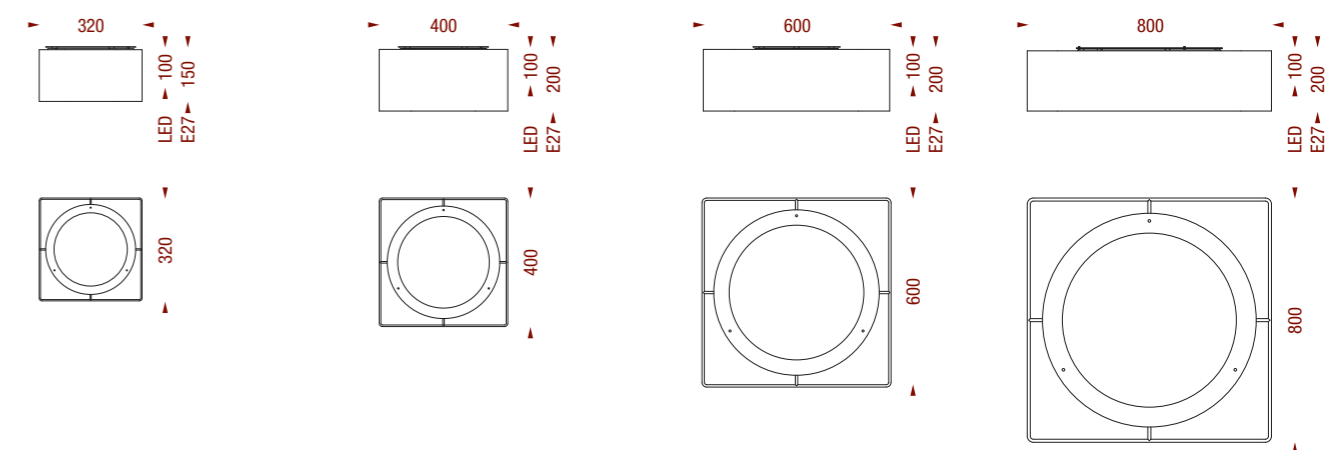

Z99-PHA-D1-E27
Z99-PHA-D1-LED

TECHNIK
2x E27 oder

LED 10W 2700K 1400lm CRI90

230 Volt

Z99-PHA-D2-E27
Z99-PHA-D2-LED

TECHNIK
2x E27 oder

LED 10W 2700K 1400lm CRI90

230 Volt

Z99-PHA-D3-E27
Z99-PHA-D3-LED

TECHNIK
3x E27 oder

LED 28W 2700K 1800lm CRI90

230 Volt

Z99-PHA-D4-E27
Z99-PHA-D4-LED

TECHNIK
4x E27 oder

LED 44W 2700K 2800lm CRI90

230 Volt

KUBA





KUBA

Z99-PKU-S1 • Z99-PKU-W2

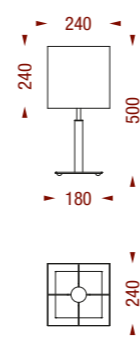

Z99-PKU-T1

TECHNIK
1x E27

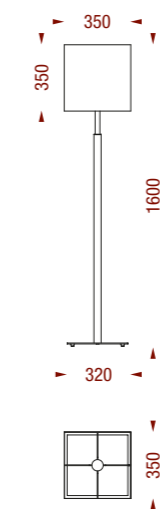

Z99-PKU-S1

TECHNIK
1x E27

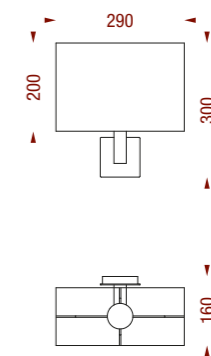

Z99-PKU-W1

TECHNIK
1x E27

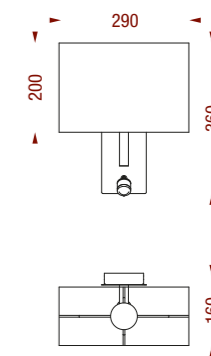

Z99-PKU-W2

TECHNIK
1x E27
+LED 2W 2700K 160lm CRI 90





Z99-PKU-H3



KUBA

Z99-PKU-D3

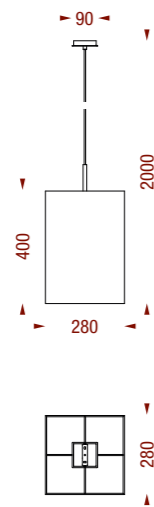

Z99-PKU-H3

TECHNIK
1x E27

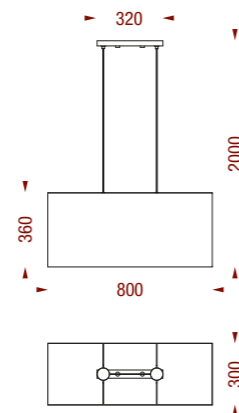

Z99-PKU-H2-2

TECHNIK
2x E27

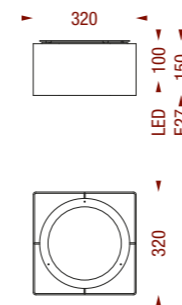

Z99-PKU-D1-E27
Z99-PKU-D1-LED

TECHNIK
2x E27 oder

LED 10W 2700K 1400lm CRI90

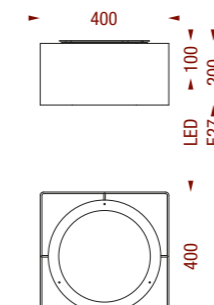
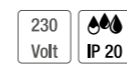

Z99-PKU-D2-E27
Z99-PKU-D2-LED

TECHNIK
2x E27 oder

LED 10W 2700K 1400lm CRI90

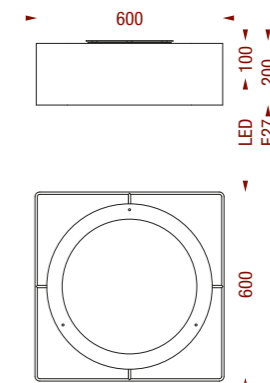

Z99-PKU-D3-E27
Z99-PKU-D3-LED

TECHNIK
3x E27 oder

LED 28W 2700K 1800lm CRI90

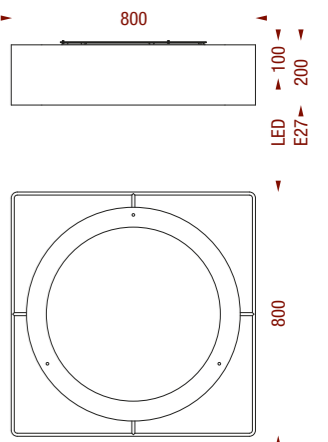

Z99-PKU-D4-E27
Z99-PKU-D4-LED

TECHNIK
4x E27 oder

LED 44W 2700K 2800lm CRI90



LENS





LENS

Z99-LEN-S1

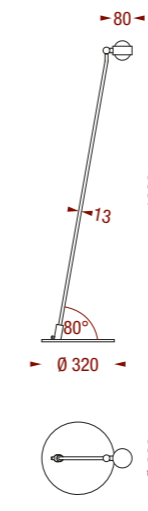

Z99-LEN-S1

TECHNIK
2x LED 5W 2700K 460lm CRI 80

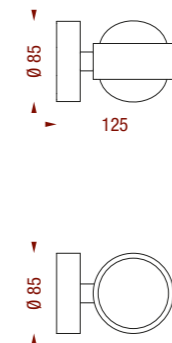

Z99-LEN-W1

TECHNIK
2x LED 5W 2700K 460lm CRI 80

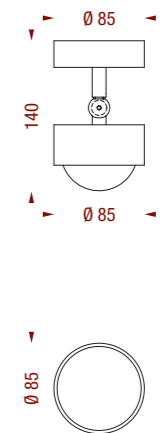

Z99-LEN-D1

TECHNIK
LED 5W 2700K 460lm CRI 80



LONDON





Z99-PLO-S1



LONDON

Z99-PLO-W1-3

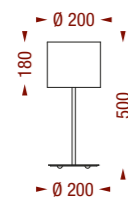

Z99-PLO-T1

TECHNIK
1x E27

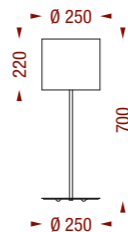

Z99-PLO-T2

TECHNIK
1x E27

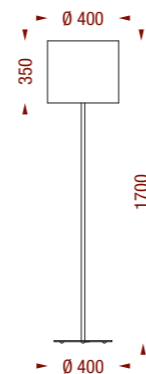

Z99-PLO-S1

TECHNIK
1x E27

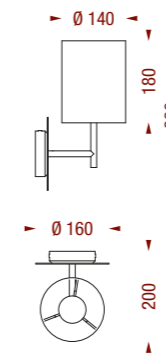

Z99-PLO-W1

TECHNIK
1x E27

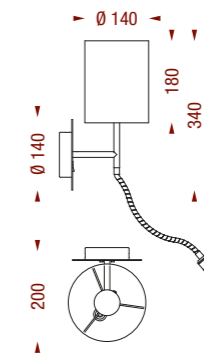

Z99-PLO-W1-3

TECHNIK
1x E27
+LED 2W 2700K 160lm CRI 90



2F

Metaloberflächen: 1 • 2 • 3 • 4
Stoffoberflächen: 1 • 2 • 3



Z99-PLO-H1



LONDON

Z99-PLO-D1

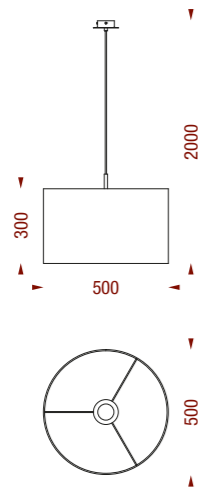

Z99-PLO-H1

TECHNIK
1x E27

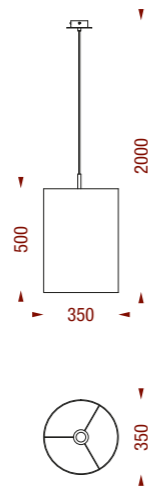

Z99-PLO-H2

TECHNIK
1x E27

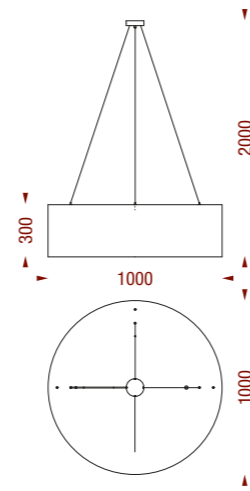

Z99-PLO-H6

TECHNIK
2xLED 95W 2700K 20000lm CRI 90

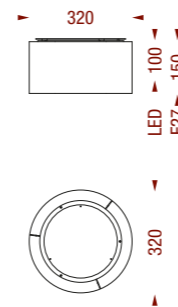

Z99-PLO-D1-E27
Z99-PLO-D1-LED

TECHNIK
2x E27 oder

LED 10W 2700K 1400lm CRI90

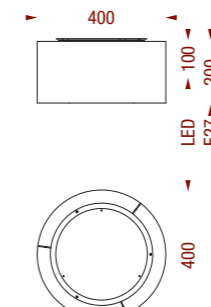

Z99-PLO-D2-E27
Z99-PLO-D2-LED

TECHNIK
2x E27 oder

LED 10W 2700K 1400lm CRI90

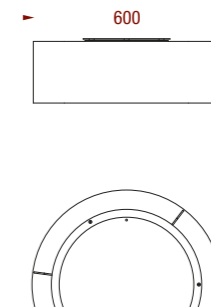

Z99-PLO-D3-E27
Z99-PLO-D3-LED

TECHNIK
3x E27 oder

LED 28W 2700K 1800lm CRI90

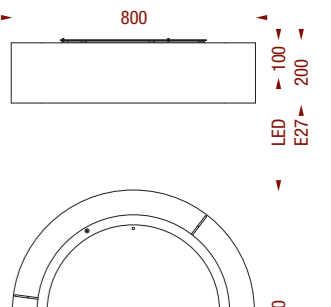

Z99-PLO-D4-E27
Z99-PLO-D4-LED

TECHNIK
4x E27 oder

LED 44W 2700K 2800lm CRI90



MALMÖ





Z99-MAL-S1



MALMÖ

Z99-MAL-W1

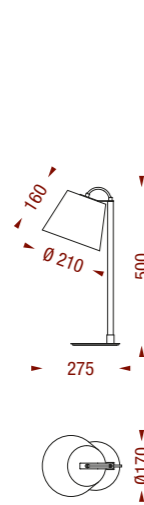

Z99-MAL-T1

TECHNIK
1x E27

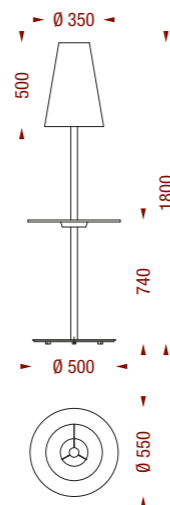

Z99-MAL-S1

TECHNIK
1x E27



Z99-MAL-W1

TECHNIK
1x E27

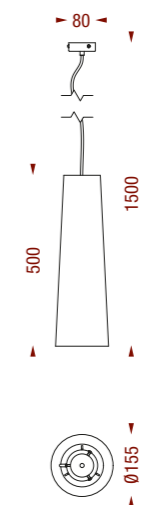

Z99-MAL-H1

TECHNIK
1x E27



MUG





Z99-MUG-S1 • Z99-MUG-T2



MUG

Z99-MUG-W3 • Z99-MUG-W2

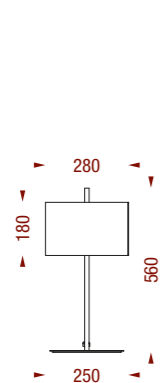

Z99-MUG-T1

TECHNIK
1x E27

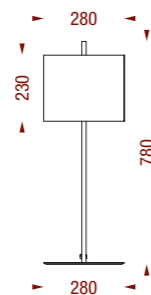

Z99-MUG-T2

TECHNIK
1x E27

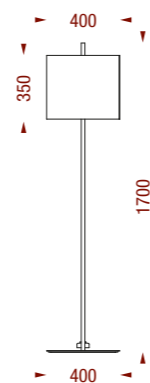

Z99-MUG-S1

TECHNIK
1x E27

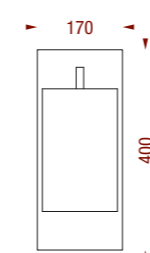

Z99-MUG-W1

TECHNIK
1x E27

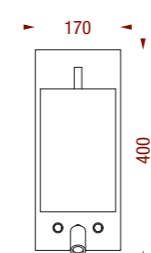

Z99-MUG-W2

TECHNIK
1x E27
+LED 2W 2700K 160lm CRI 90

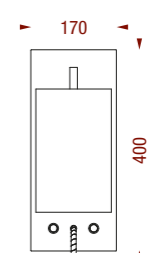

Z99-MUG-W3

TECHNIK
1x E27
+LED 2W 2700K 160lm CRI 90





Z99-MUG-H1

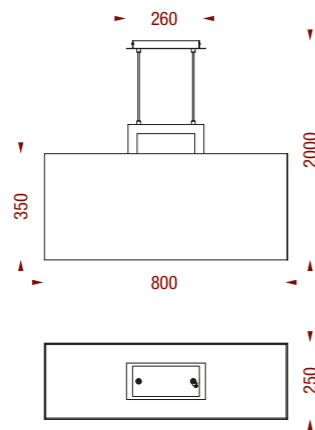

Z99-MUG-H1

TECHNIK

2x E27



MUG

Z99-MUG-D2

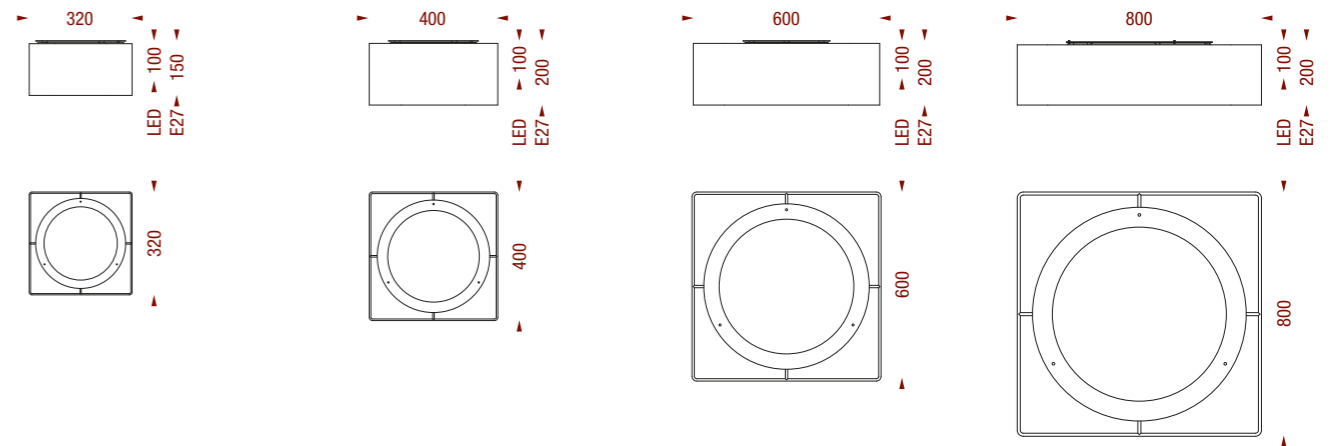

Z99-MUG-D1-E27
Z99-MUG-D1-LED

TECHNIK

2x E27 oder

LED 10W 2700K 1400lm CRI90



Z99-MUG-D2-E27
Z99-MUG-D2-LED

TECHNIK

2x E27 oder

LED 10W 2700K 1400lm CRI90



Z99-MUG-D3-E27
Z99-MUG-D3-LED

TECHNIK

3x E27 oder

LED 28W 2700K 1800lm CRI90



Z99-MUG-D4-E27
Z99-MUG-LED

TECHNIK

4x E27 oder

LED 44W 2700K 2800lm CRI90



NATURE





Z99-PNA-S1 • Z99-PNA-T3



NATURE

Z99-PNA-W4 • Z88-PNA-W5

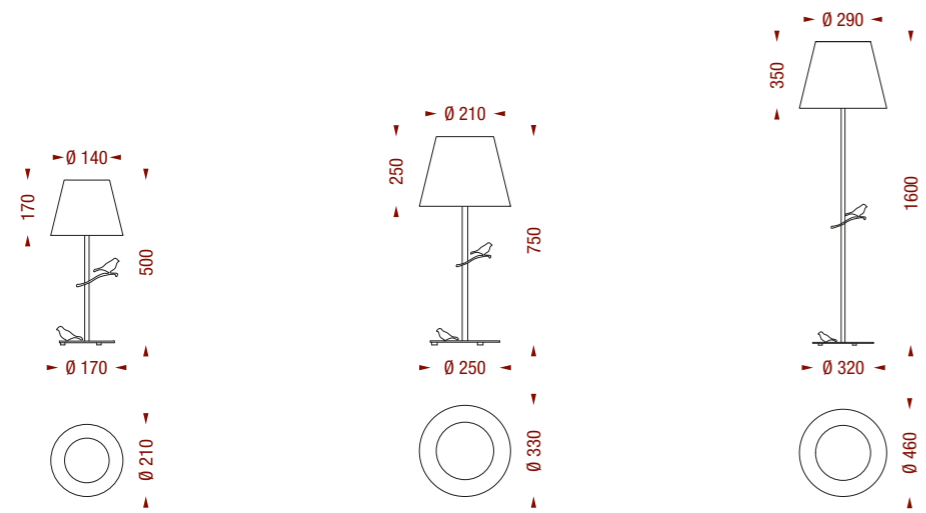

Z99-PNA-T3

TECHNIK
1x E27

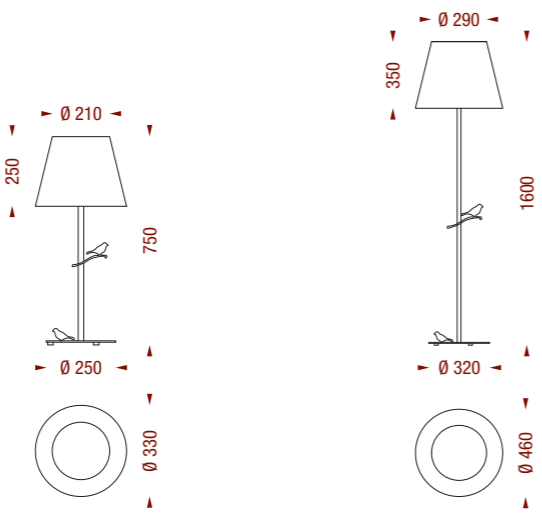

Z99-PNA-T4

TECHNIK
1x E27

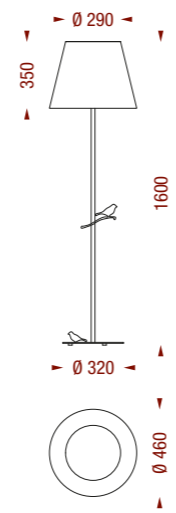

Z99-PNA-S1

TECHNIK
1x E27

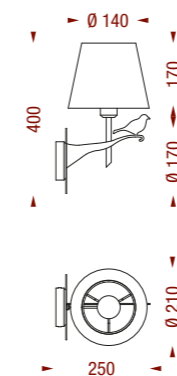

Z99-PNA-W3

TECHNIK
1x E27

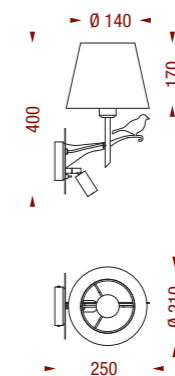

Z99-PNA-W4

TECHNIK
1x E27
+LED 2W 2700K 160lm CRI 90

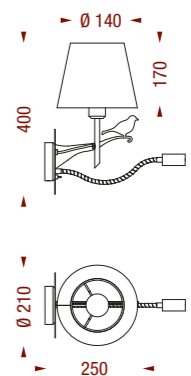

Z99-PNA-W5

TECHNIK
1x E27
+LED 2W 2700K 160lm CRI 90





Z99-PNA-H2



NATURE

Z99-PNA-D3

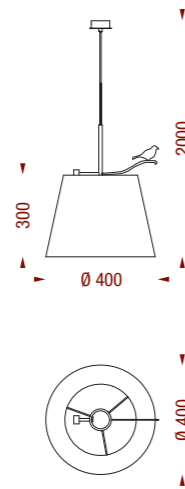

Z99-PNA-H2

TECHNIK
1x E27

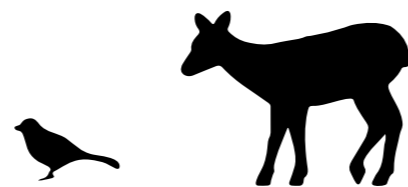
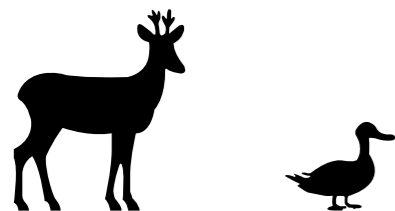

Weitere Motive und Logos sind auf Anfrage möglich

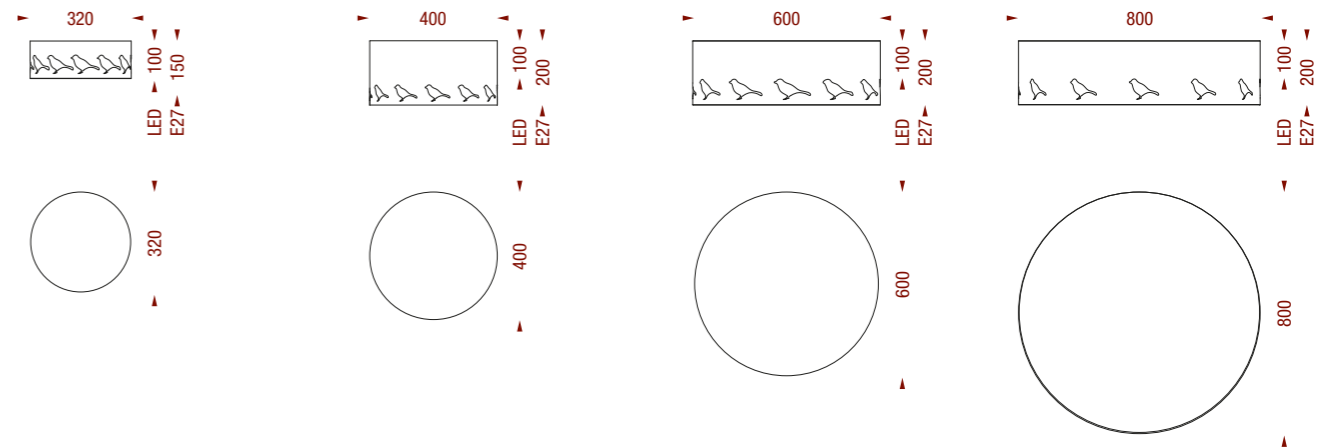

Z99-PNA-D1-E27
Z99-PNA-D1-LED

TECHNIK
2x E27 oder

LED 10W 2700K 1400lm CRI90



Z99-PNA-D2-E27
Z99-PNA-D2-LED

TECHNIK
2x E27 oder

LED 10W 2700K 1400lm CRI90



Z99-PNA-D3-E27
Z99-PNA-D3-LED

TECHNIK
3x E27 oder

LED 28W 2700K 1800lm CRI90



Z99-PNA-D4-E27
Z99-PNA-D4-LED

TECHNIK
4x E27 oder

LED 44W 2700K 2800lm CRI90



NEW YORK





Z99-NEW-S1



NEW YORK

Z99-NEW-W1

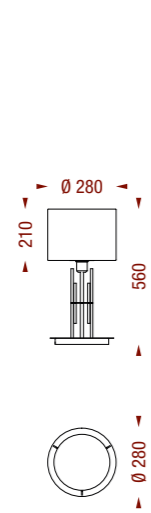

Z99-NEW-T1

TECHNIK
1x E27

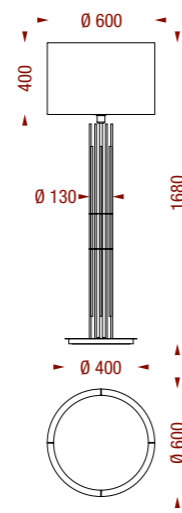

Z99-NEW-S1

TECHNIK
1x E27

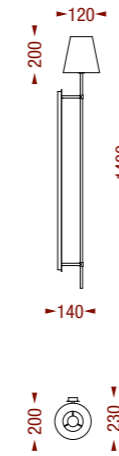

Z99-NEW-W1

TECHNIK
1x E27

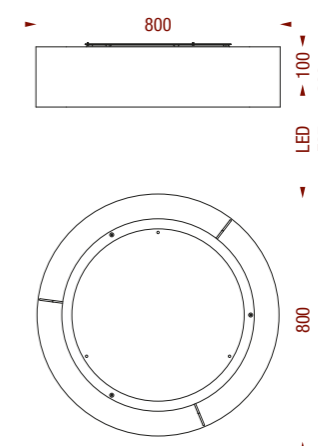

Z99-NEW-D1

TECHNIK
4x E27 oder
LED 44W 2700K 2800lm CRI90



ORBIT





Z99-ORB-W2 • Z99-ORB-S1



ORBIT

Z99-ORB-H1 • Z99-ORB-H2

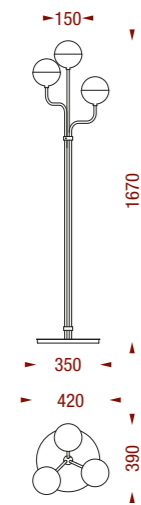

Z99-ORB-S1

TECHNIK

3x G9

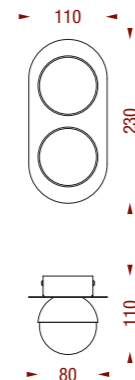

Z99-ORB-W1

TECHNIK

2x LED 8W • 2700K • 350lm



Z99-ORB-W2

TECHNIK

LED 8W • 2700K • 350 lm
LED 2W • 2700K • 160 lm



Z99-ORB-H1

TECHNIK

1x G9

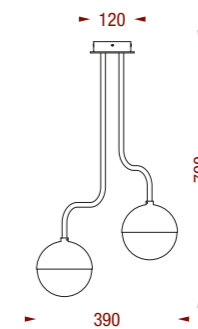

Z99-ORB-H2

TECHNIK

2x G9



OSLO





OSLO

Z99-OSL-H1 • Z99-OSL-W1

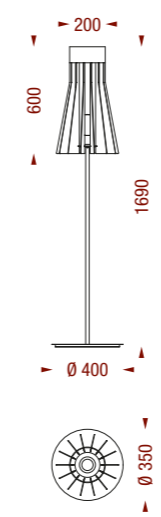

Z99-OSL-S1

TECHNIK
1x E27

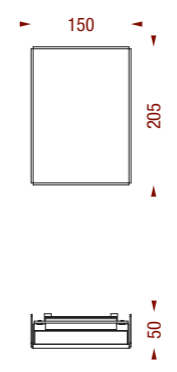

Z99-OSL-W1

TECHNIK
LED 8W 2700K 600lm 350mA

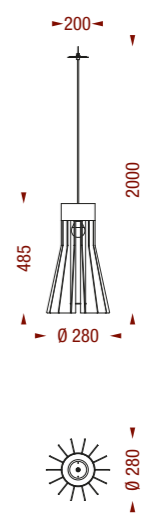

Z99-OSL-H1

TECHNIK
1x E27



PARIS





Z99-PAR-T1 • Z99-PAR-T2



PARIS

Z99-PAR-S1 • Z99-PAR-S2

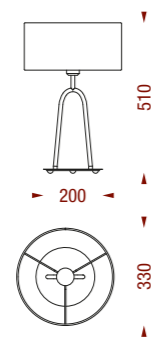

Z99-PAR-T1

TECHNIK
1x E27

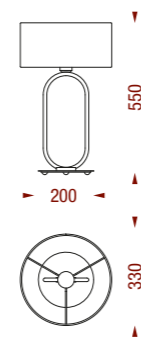

Z99-PAR-T2

TECHNIK
1x E27

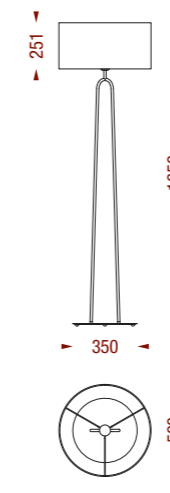

Z99-PAR-S1

TECHNIK
1x E27

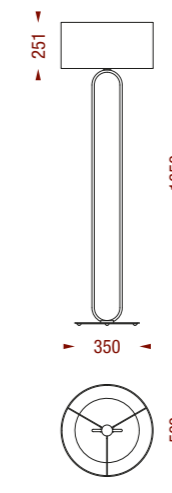

Z99-PAR-S2

TECHNIK
1x E27



2F

Metaloberflächen: 1 • 2 • 3 • 4
Stoffoberflächen: 1 • 2 • 3



Z99-PAR-T1
ARCOTEL CASTELLANI • Salzburg

© Harald Eisenberger



PARIS

Z99-PAR-H1 • Z99-PAR-H2

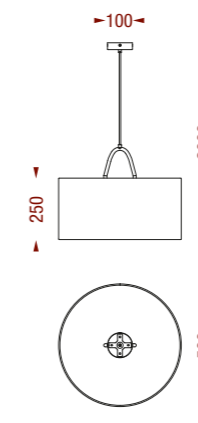

Z99-PAR-H1

TECHNIK
 1x E27

230 Volt IP 20

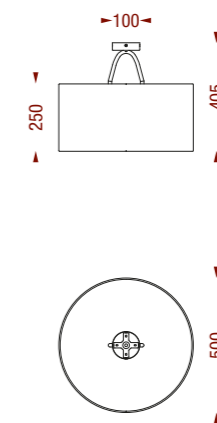

Z99-PAR-D1

TECHNIK
 1x E27

230 Volt IP 20

2F

Metalloberflächen: 1 • 2 • 3 • 4
 Stoffoberflächen: 1 • 2 • 3

PEBBLE





Z99-PPE-T2



PEBBLE

Z99-PPE-W1-2

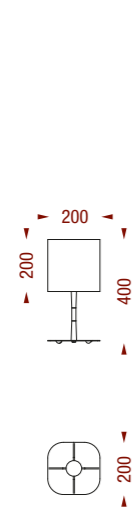

Z99-PPE-T1

TECHNIK
1x E27



Z99-PPE-T2

TECHNIK
1x E27



Z99-PPE-S1

TECHNIK
1x E27

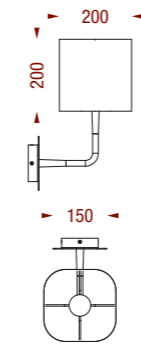

Z99-PPE-W1

TECHNIK
1x E27

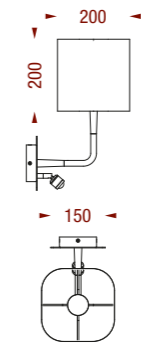

Z99-PPE-W1-2

TECHNIK
1x E27
+LED 2W 2700K 160lm CRI 90

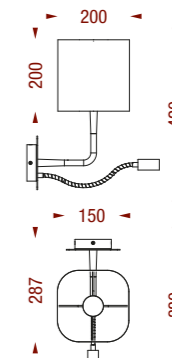

Z99-PPE-W1-3

TECHNIK
1x E27
+LED 2W 2700K 160lm CRI 90





Z99-PPE-W6



PEBBLE

Z99-PPE-W2

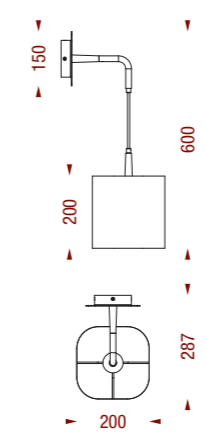

Z99-PPE-W2

TECHNIK
1x E27

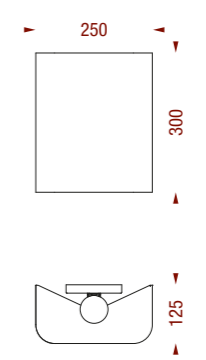
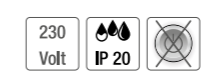

Z99-PPE-W6

TECHNIK
1x E27

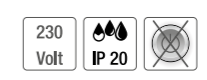

2F

Metalloberflächen: 1 • 2 • 3 • 4
Stoffoberflächen: 1 • 2 • 3



Z99-PPE-H1



PEBBLE

Z99-PPE-D3

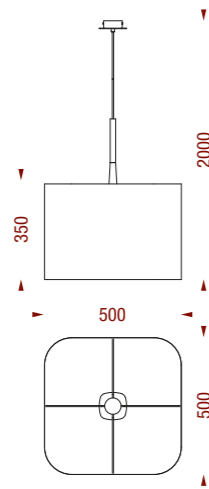

Z99-PPE-H1

TECHNIK
1x E27

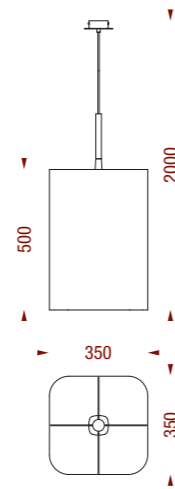

Z99-PPE-H2

TECHNIK
1x E27

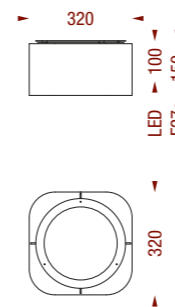

Z99-PPE-D1-E27
Z99-PPE-D1-LED

TECHNIK
2x E27 oder

LED 10W 2700K 1400lm CRI90

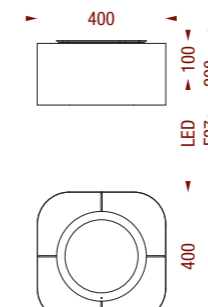

Z99-PPE-D2-E27
Z99-PPE-D2-LED

TECHNIK
2x E27 oder

LED 10W 2700K 1400lm CRI90

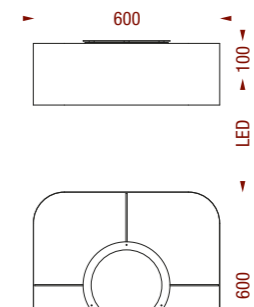

Z99-PPE-D3-E27
Z99-PPE-D3-LED

TECHNIK
3x E27 oder

LED 28W 2700K 1800lm CRI90

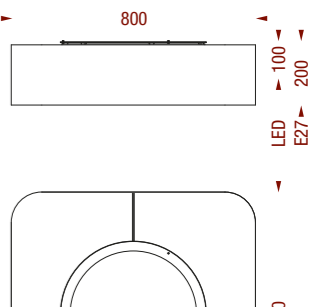

Z99-PPE-D4-E27
Z99-PPE-D4-LED

TECHNIK
4x E27 oder

LED 44W 2700K 2800lm CRI90



PRINCIPLE





Z99-PRI-T1 • Z99-PRI-S1



Z99-PRI-W1 • Z99-PRI-D1

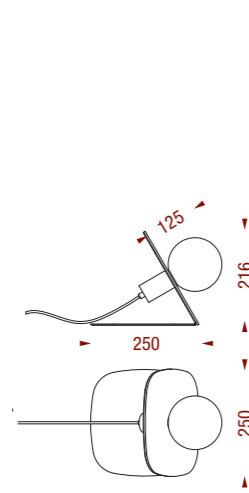

Z99-PRI-T1

TECHNIK
1x E27

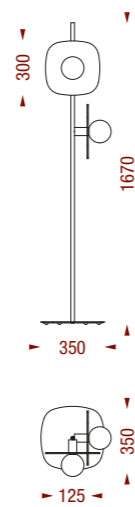

Z99-PRI-S1

TECHNIK
2x E27

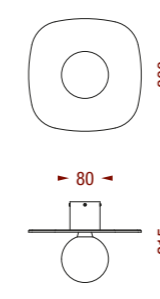

Z99-PRI-W1

TECHNIK
1x E27

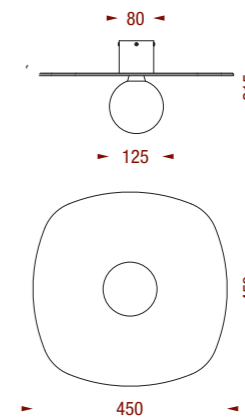

Z99-PRI-D1

TECHNIK
1x E27





Z99-PRI-H1



PRINCIPLE

Z99-PRI-H1

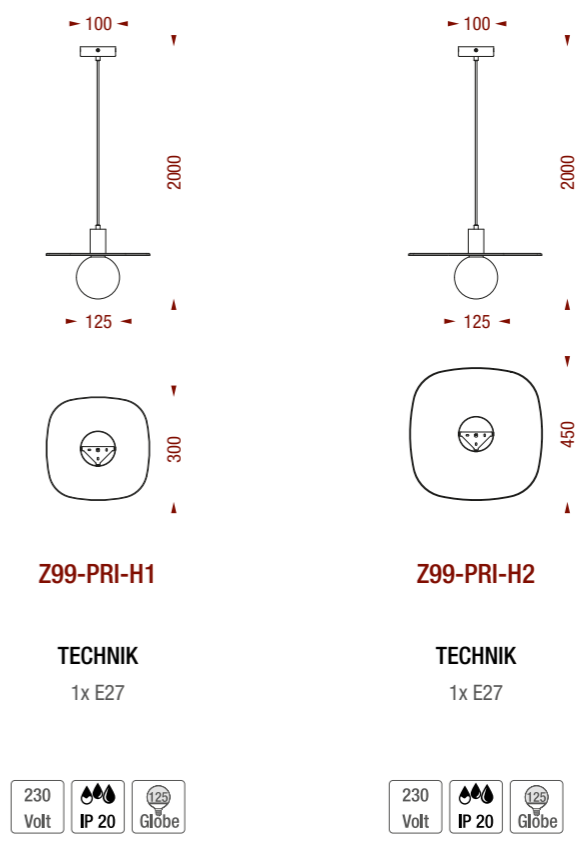

Z99-PRI-H1

Z99-PRI-H2

TECHNIK

TECHNIK

1x E27

1x E27

230 Volt IP 20 125 Glöbe

230 Volt IP 20 125 Glöbe



Metalloberflächen: 1 • 2 • 3 • 4

RUSTICA





Z99-PRU-S1 • Z99-PRU-T1



RUSTICA

Z99-PRU-W1

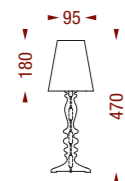

Z99-PRU-T1

TECHNIK
1x E27

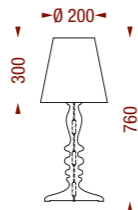

Z99-PRU-T2

TECHNIK
1x E27

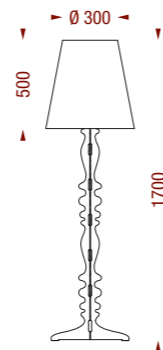

Z99-PRU-S1

TECHNIK
1x E27

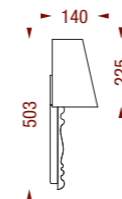

Z99-PRU-W1

TECHNIK
1x E27

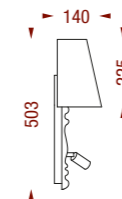

Z99-PRU-W1-2

TECHNIK
1x E27
LED 2W 2700K 160lm CRI 90

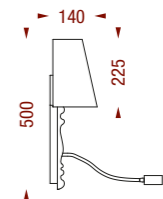

Z99-PRU-W1-3

TECHNIK
1x E27
LED 2W 2700K 160lm CRI 90





Z99-PRU-H1



RUSTICA

Z99-PRU-W1 • Z99-PRU-D2

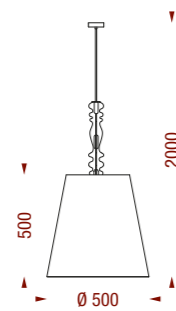

Z99-PRU-H1

TECHNIK
1x E27

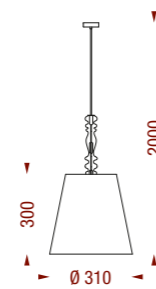

Z99-PRU-H2

TECHNIK
1x E27

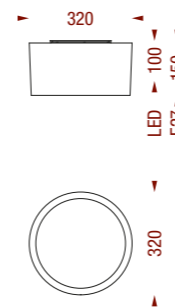

Z99-PRU-D1-E27
Z99-PRU-D1-LED

TECHNIK
2x E27 oder

LED 10W 2700K 1400lm CRI90

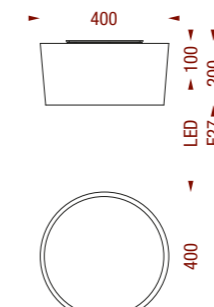
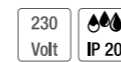

Z99-PRU-D2-E27
Z99-PRU-D2-LED

TECHNIK
2x E27 oder

LED 10W 2700K 1400lm CRI90

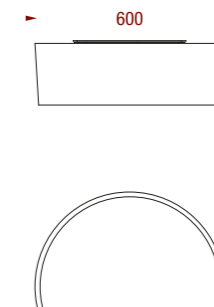
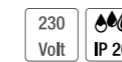

Z99-PRU-D3-E27
Z99-PRU-D3-LED

TECHNIK
3x E27 oder

LED 28W 2700K 1800lm CRI90

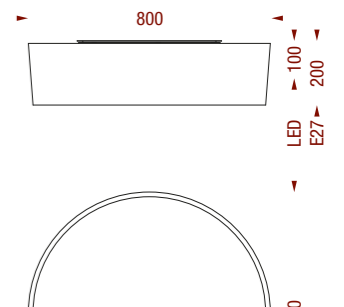
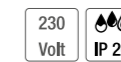

Z99-PRU-D4-E27
Z99-PRU-D4-LED

TECHNIK
4x E27 oder

LED 44W 2700K 2800lm CRI90



SEED





Z99-PSE-T2



SEED

Z99-PSE-W1-2

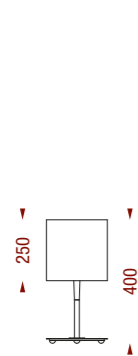

Z99-PSE-T1

TECHNIK
1x E27

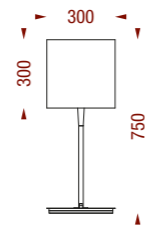

Z99-PSE-T2

TECHNIK
1x E27

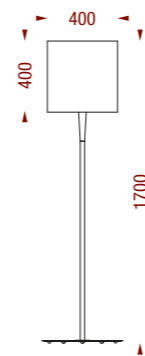

Z99-PSE-S1

TECHNIK
1x E27

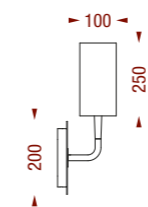

Z99-PSE-W1

TECHNIK
1x E27

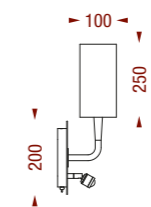

Z99-PSE-W1-2

TECHNIK
1x E27
LED 2W 2700K 160lm CRI 90

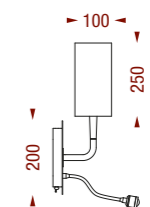

Z99-PSE-W1-3

TECHNIK
1x E27
LED 2W 2700K 160lm CRI 90



2F

Metalloberflächen: 1 • 2 • 3 • 4
Stoffoberflächen: 1 • 2 • 3



Z99-PSE-T2
HOTEL GERL • Salzburg



SEED

Z99-PSE-W2

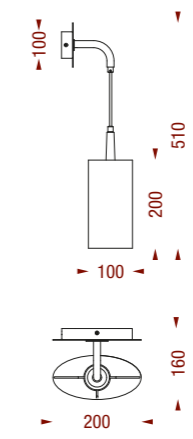

Z99-PSE-W2

TECHNIK
1x E27

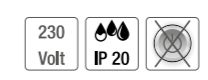

2F Metalloberflächen: 1 • 2 • 3 • 4
Stoffoberflächen: 1 • 2 • 3



Z99-PSE-H1

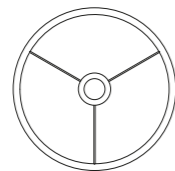
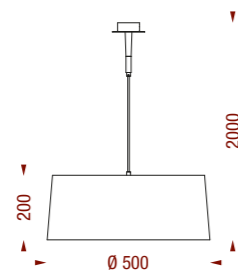

Z99-PSE-H1

TECHNIK
1x E27

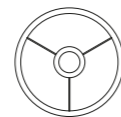
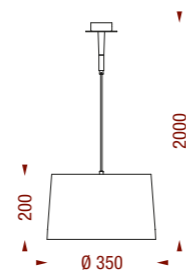

Z99-PSE-H2

TECHNIK
1x E27



SEED

Z99-PSE-D2

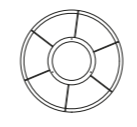
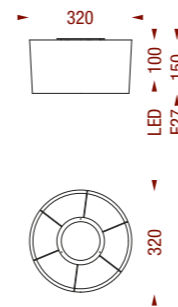

Z99-PSE-D1-E27
Z99-PSE-D1-LED

TECHNIK
2x E27 oder

LED 10W 2700K 1400lm CRI90

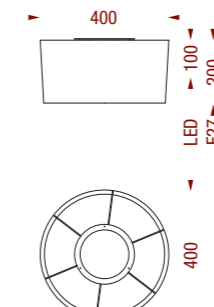

Z99-PSE-D2-E27
Z99-PSE-D2-LED

TECHNIK
2x E27 oder

LED 10W 2700K 1400lm CRI90

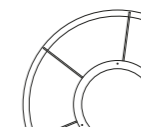
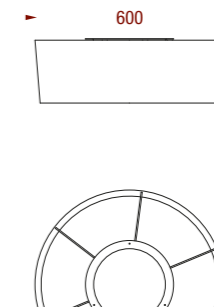

Z99-PSE-D3-E27
Z99-PSE-D3-LED

TECHNIK
3x E27 oder

LED 28W 2700K 1800lm CRI90

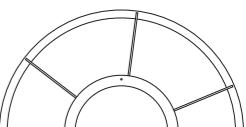
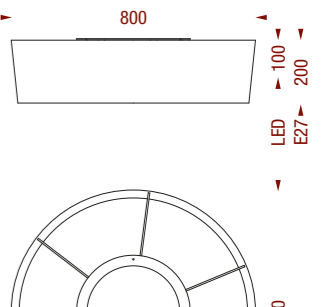

Z99-PSE-D4-E27
Z99-PSE-D4-LED

TECHNIK
4x E27 oder

LED 44W 2700K 2800lm CRI90



TAPER





Z99-TAP-S1 • Z99-TAP-T1



TAPER

Z99-TAP-W1 • Z99-TAP-H1

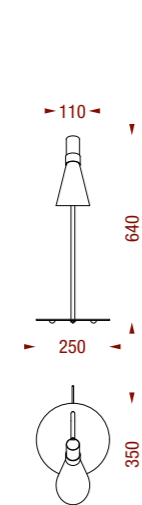

Z99-TAP-T1

TECHNIK
1x E14

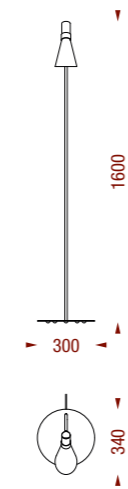

Z99-TAP-S1

TECHNIK
1x E14

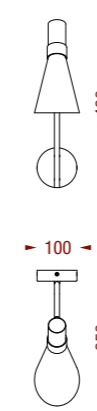

Z99-TAP-W1

TECHNIK
1x E14

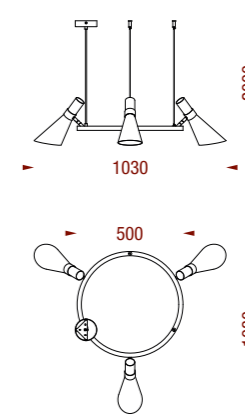

Z99-TAP-H1

TECHNIK
3x E14



READING



Z99-H0769 • LED-3-FL200-D1S-E

KAISERLODGE • Scheffau

© Günter Staudl



Z99-PMO-W2-LED
HOTEL GUT BRANDLHOF • Saalfelden



READING

Z99-PMO-W1-LED

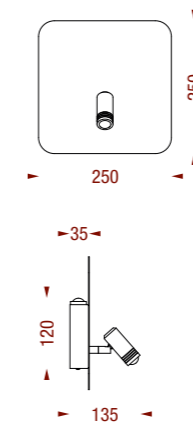

Z99-PMO-W1-LED

TECHNIK
2x LED 2W • 2700K • 160lm

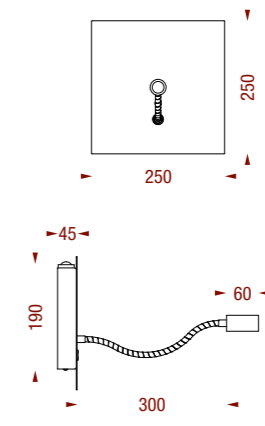

Z99-PMO-W2-LED

TECHNIK
2x LED 2W • 2700K • 160lm



Metalloberflächen: 1 • 2 • 3 • 4



READING

Z99-PULPO-R

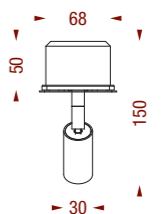
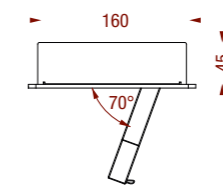
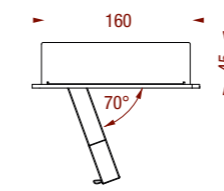
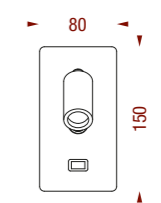
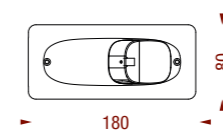
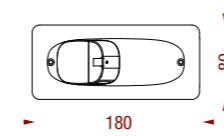

Z99-PULPO-L

Z99-PULPO-R

LED-3-D5S-G-USB

TECHNIK
LED 2W 2700K • 160lm

TECHNIK
LED 2W 2700K • 160lm

TECHNIK
LED 2W 2700K • 160lm





Z99-ECL-H1 • Z99-HIDDEN
ALMANAC • Barcelona

© Sivan Askayo



READING

Z99-HIDDEN • Z99-HID-D1S • Z99-PIPE

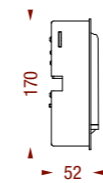
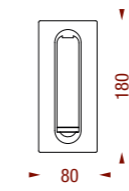

Z99-HIDDEN

TECHNIK
 LED 2W 2700K 160lm

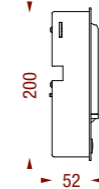
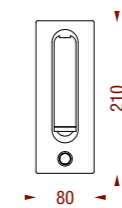
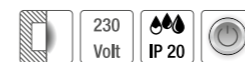

Z99-HID-D1S

TECHNIK
 LED 2W 2700K 160lm

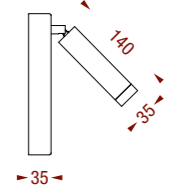
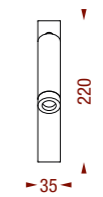

Z99-PIPE

TECHNIK
 LED 2W 2700K 160lm



2F

Metalloberflächen: 1 • 2 • 3 • 4

READING MODULAR



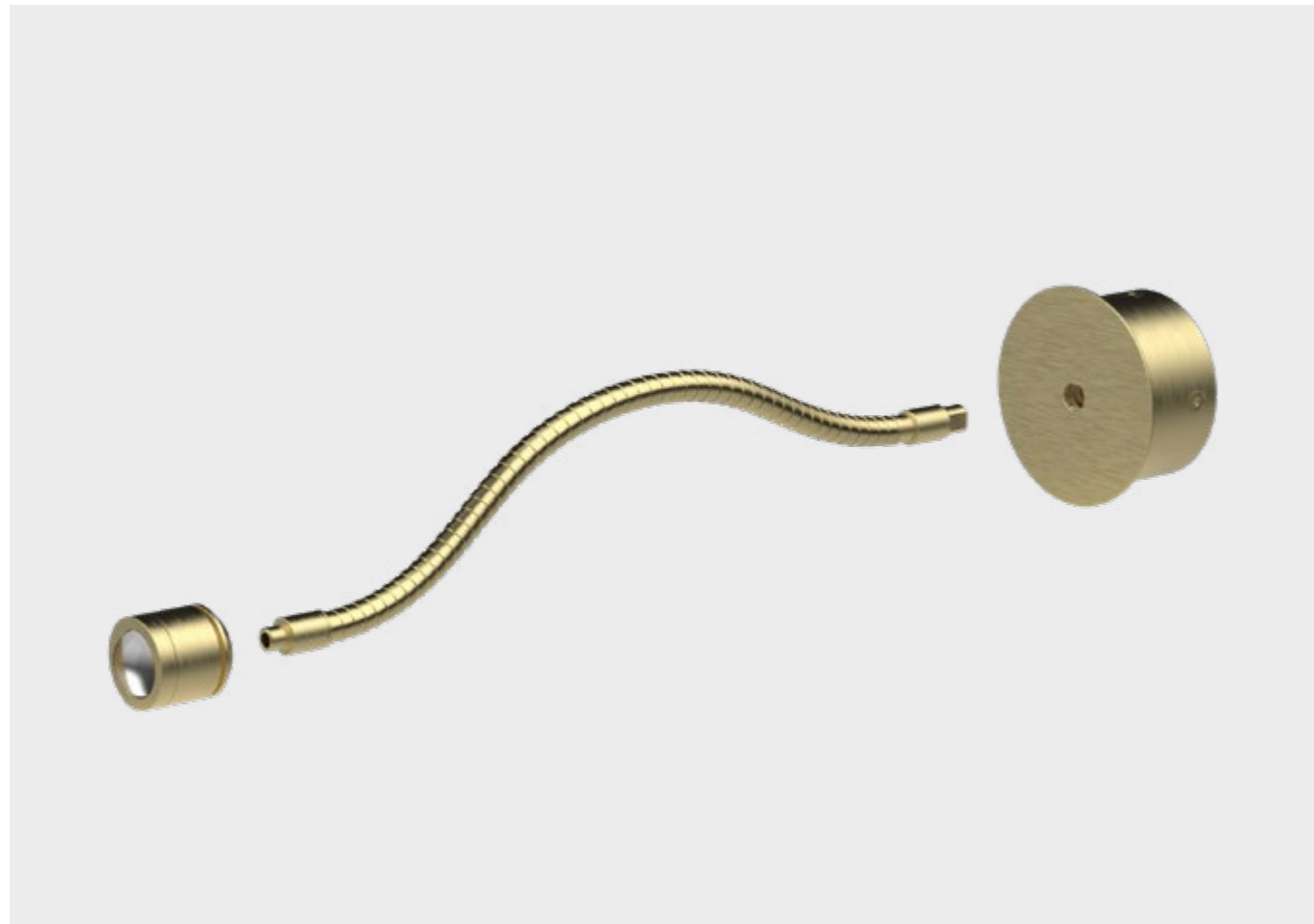

Bestellbeispiel: LED-2-FL-300-D1-A

230 Volt 2 Watt IP 20 160 Lumen 2700K



LED-1



LED-2



LED-3



LED-5



G-50



FL-200



FL-300

Einbauvariante



D1-E



D2-E



D1S-E



D2S-E

Aufbauvariante



D1-A



D2-A



D1S-A



D2S-A

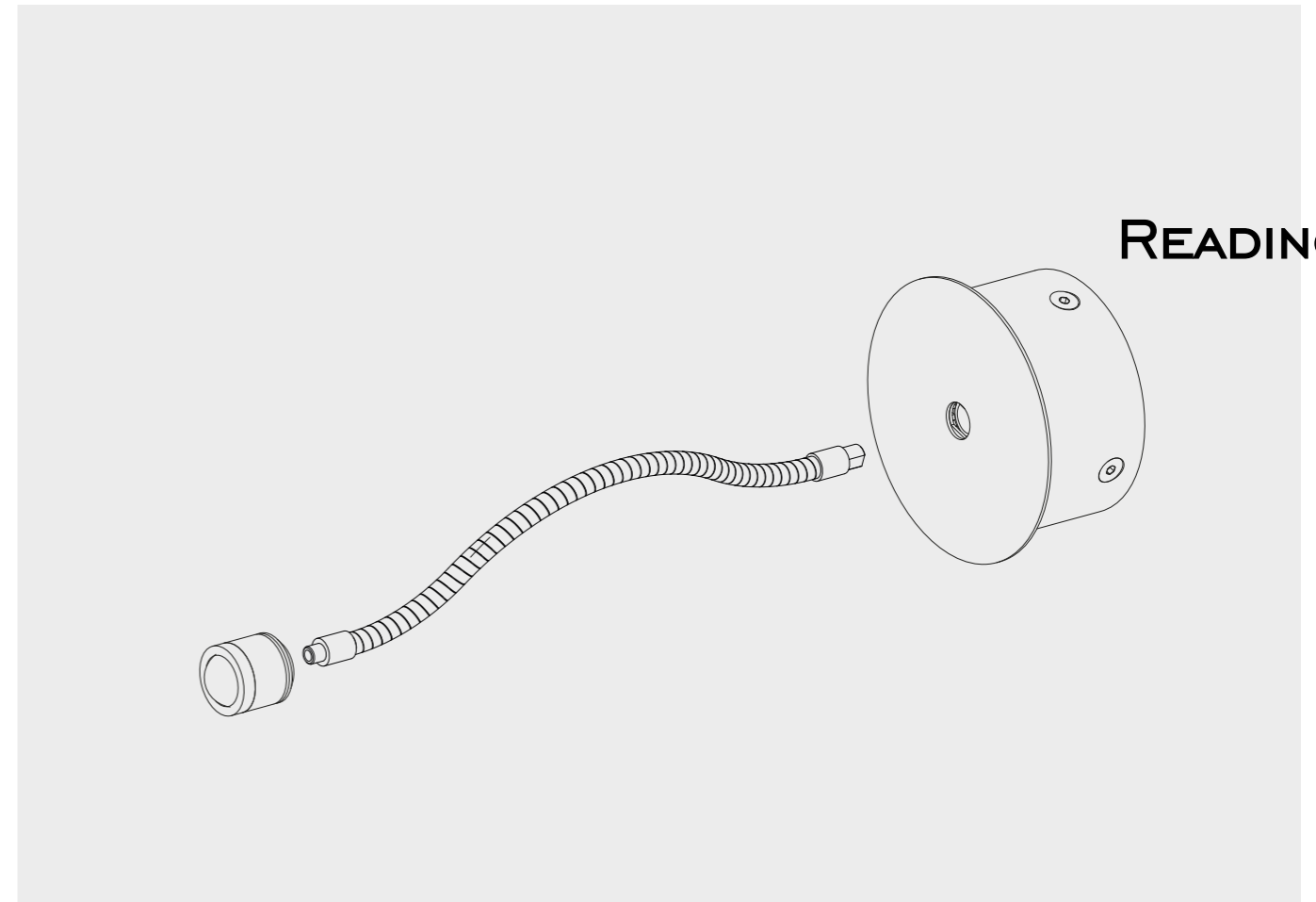

READING

Bestellbeispiel: LED-2-FL-300-D1-A

230 Volt 2 Watt IP 20 160 Lumen 2700K



LED-1

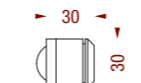

LED-2



LED-3

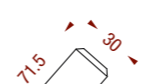

LED-5

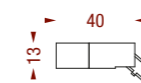

G-50

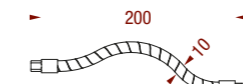

FL-200



FL-300

Einbauvariante

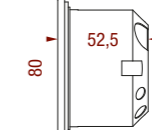

D1-E

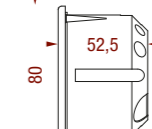

D2-E

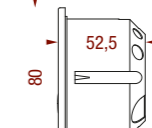

D1S-E

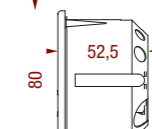

D2S-E

Aufbauvariante

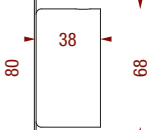

D1-A

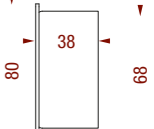

D2-A

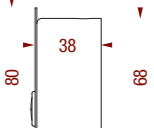

D1S-A

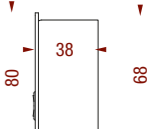

D2S-A

OUTDOOR





Z99-H0692
AUGUSTIN • München

© DESIGN Manzenreiter



OUTDOOR

Z99-S0255-SO • Z99-H0692

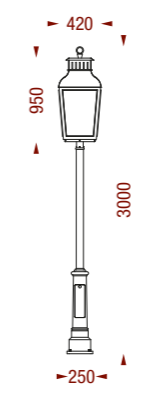

Z99-S0255

TECHNIK
 1x E27

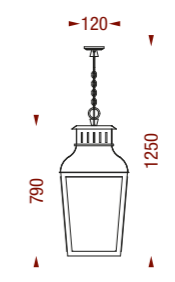

Z99-H0692

TECHNIK
 1x E27



2F Metalloberflächen: 1 • 2



Z99-W0207-1 • Z99-S0438

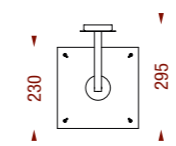
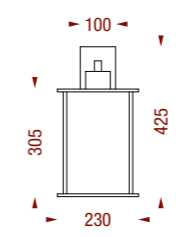

Z99-W0207-1

TECHNIK
1x E27

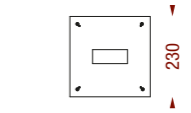
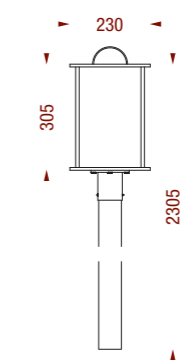

Z99-S0438

TECHNIK
1x E27





Z99-H0664



OUTDOOR

Z99-H0664-2 • Z99-H0664-1

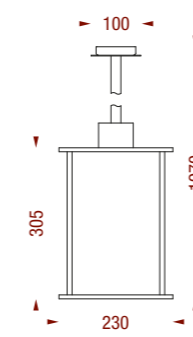

Z99-H0664

TECHNIK
1x E27

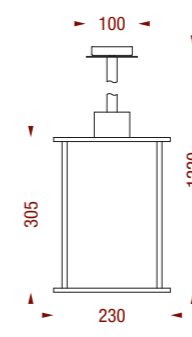

Z99-H0664-1

TECHNIK
1x E27

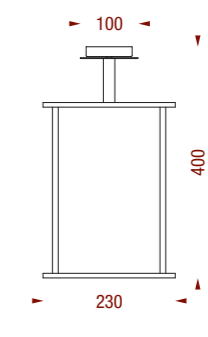

Z99-H0664-2

TECHNIK
1x E27





OUTDOOR

Z99-BEA-W1 • Z99-BEA-D1

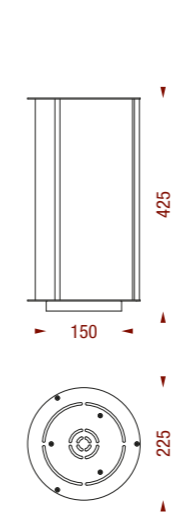

Z99-BEA-B1

TECHNIK
1x E27

230 Volt IP 44

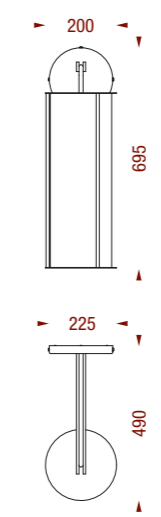

Z99-BEA-W1

TECHNIK
1x E27

230 Volt IP 44

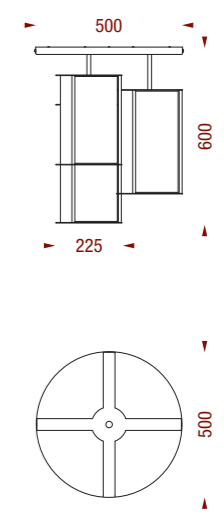

Z99-BEA-D1

TECHNIK
3x E27

230 Volt IP 44



Z99-S0516-1
TAUERN SPA ZELL AM SEE • Kaprun



OUTDOOR

Z99-S0516-1

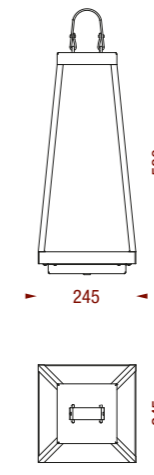

Z99-S0516-1

TECHNIK
LED 5W 2700K 480lm

230
Volt  IP 54

2F Metaloberflächen: 1 • 2



OUTDOOR

Z99-W0489-2 • Z99-IF-12046-2 • Z99-H0171

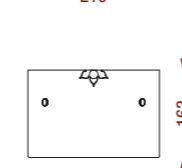
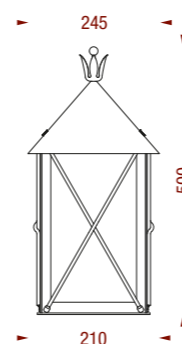

Z99-W0489-1

TECHNIK
1x E27

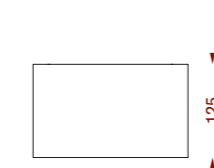
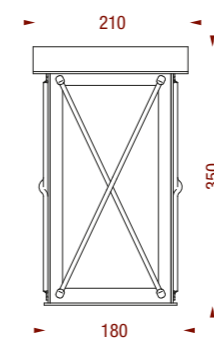

Z99-W0489-2

TECHNIK
1x E27

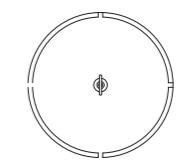
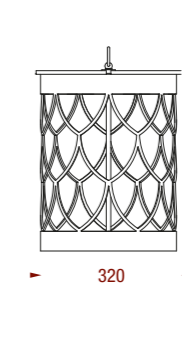

Z99-IF-12046-2

TECHNIK
LED 16W 2700K 1500lm

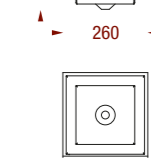
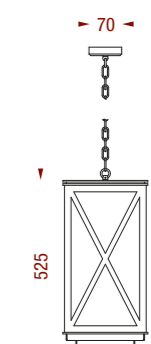

Z99-H0171

TECHNIK
1x E27





OUTDOOR

Z99-S5002-2 • Z99-S5002-1 • Z99-S5002

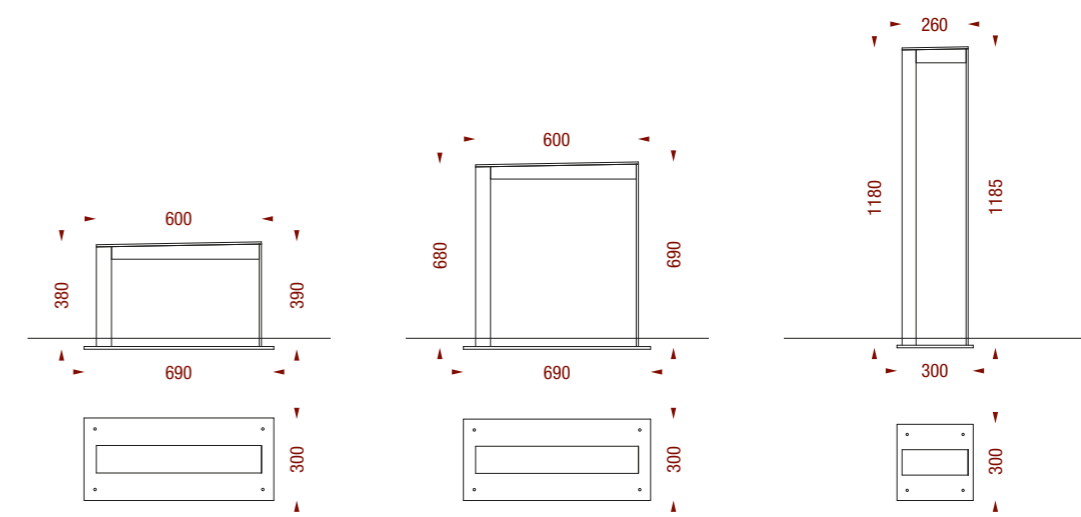

Z99-S5002-2

Z99-S5002-1

Z99-S5002

TECHNIK
LED 30W 2700K 2500lm

TECHNIK
LED 30W 2700K 2500lm

TECHNIK
LED 10W 2700K 900lm

230 Volt IP 65

230 Volt IP 65

230 Volt IP 65



BEACH

Z587-2035LT
VIENNA BALTIC HOUSE • Wien

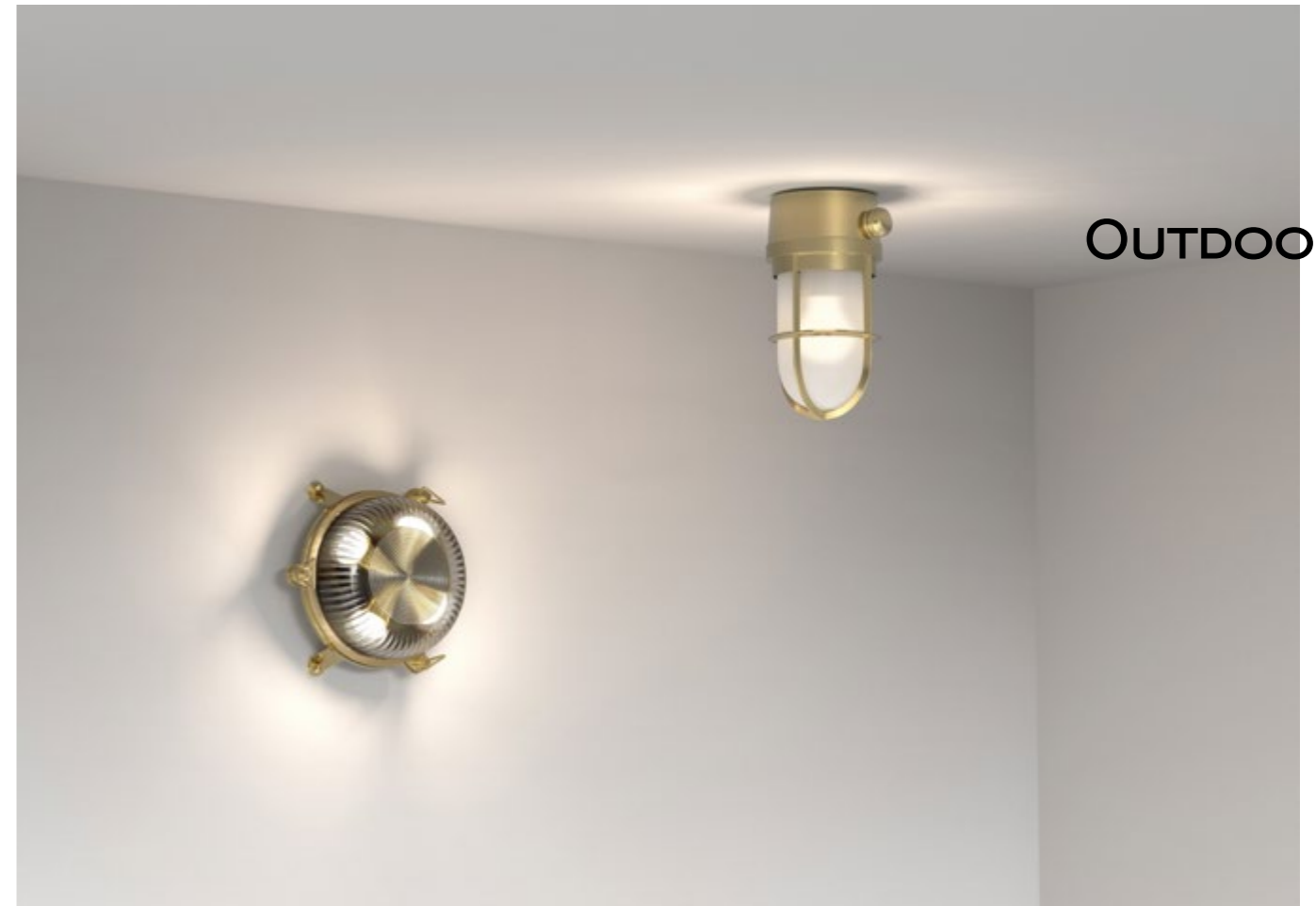

Z587-2136LT • Z587-2296LS

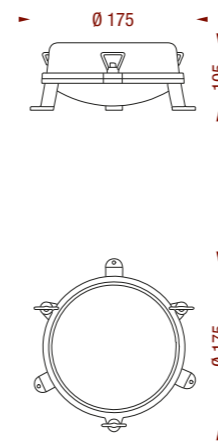

Z587-2136LT

TECHNIK
1x E27

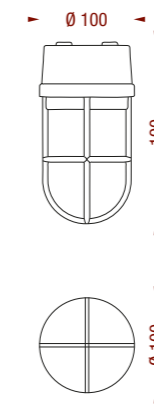

Z587-2296LS

TECHNIK
1x E27

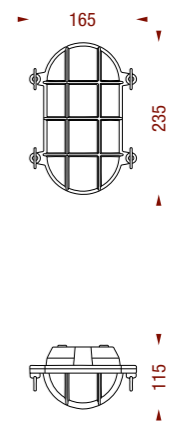

Z587-2035LT

TECHNIK
1x E27



Metalloberflächen: 3 (nur in GO & CR möglich)

BATTERY





Z801-F1001-360A • Z801-F1002-360A • Z801-F1100-360B



Z801-F1010-300B • Z801-F1010-500B

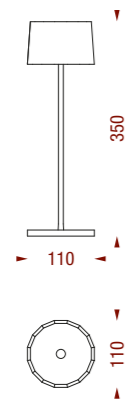

Z801-F1001-360A

TECHNIK
AKKU 3,7V
LED 2,2W 3000K 150lm

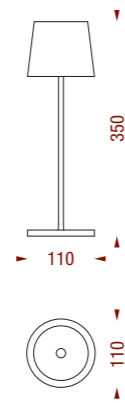

Z801-F1002-360A

TECHNIK
AKKU 3,7V
LED 2,2W 3000K 150lm

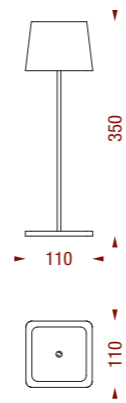

Z801-F1100-360B

TECHNIK
AKKU 3,7V
LED 2,2W 3000K 150lm

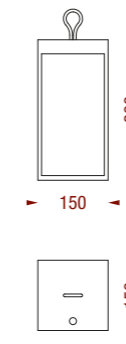

Z801-F1010-300B

TECHNIK
AKKU 3,7V
LED 2,2W 3000K 200lm

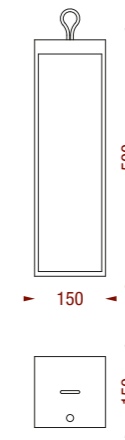

Z801-F1010-500B

TECHNIK
AKKU 3,7V
LED 2,2W 3000K 200lm



MIRRORS





Z99-SP199-1
HILTON • Bukarest



Z99-SP209
SCHLOSS MARBACH • Marbach
© Schloss Marbach



MIRRORS

© Schloss Marbach

Z99-SP209 • Z99-H1310



Z99-SP192-900
The MATTHEW - Copper Lodge • Wagrain
© Geisler & Trimmel

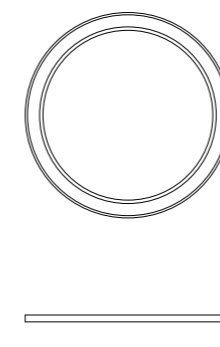

Z99-SP192-900

TECHNIK
LED 30W 2700K 2300lm

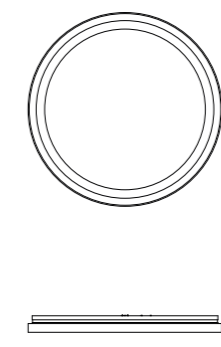

Z99-SP199-1

TECHNIK
LED 32W 3000K 2300lm (indirekt)
LED 16W 3000K 1700lm (direkt)

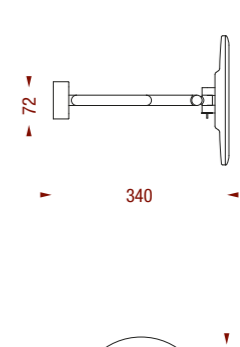

Z99-SP209

TECHNIK
LED 6W 3000K 66lm
(nur in CR & SWM möglich)

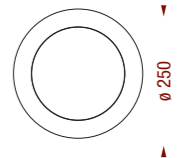

Metalloberflächen: 1 • 2 • 3 • 4



Z99-W0397-2 • Z99-S0394 • Z99-SP144
HYATT REGENCY • Amsterdam

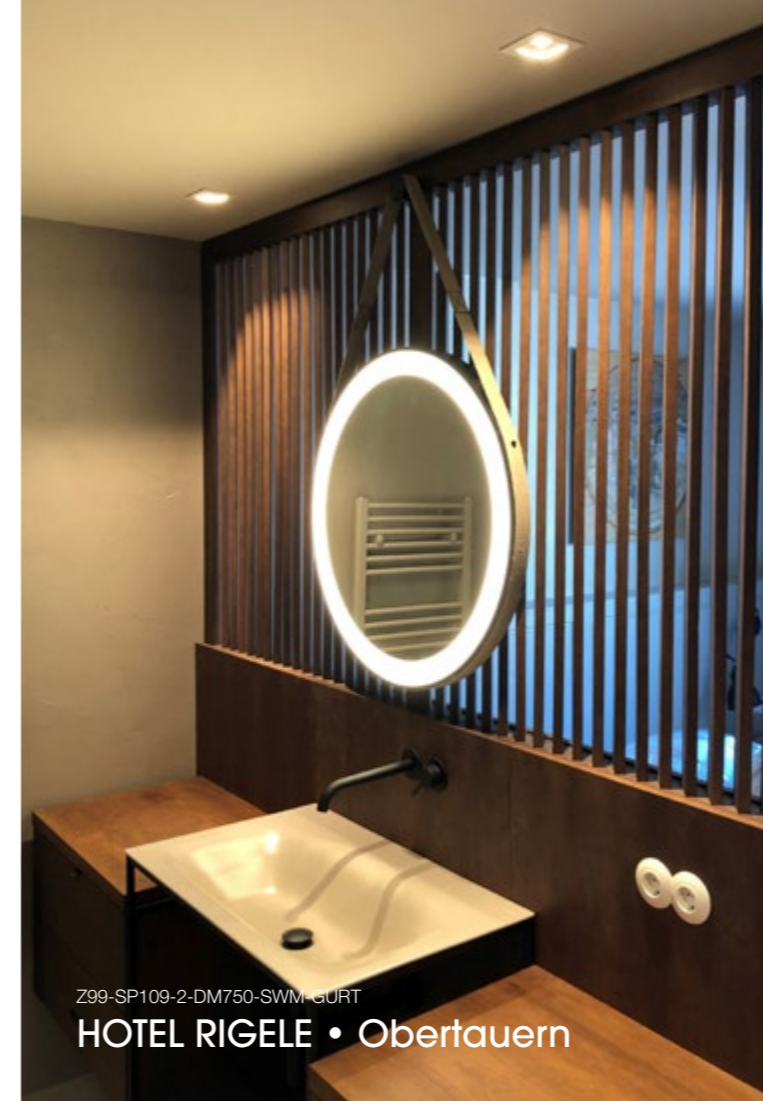

Z99-SP109-2-DM750-SWM-GURT
HOTEL RIGELE • Obertauern

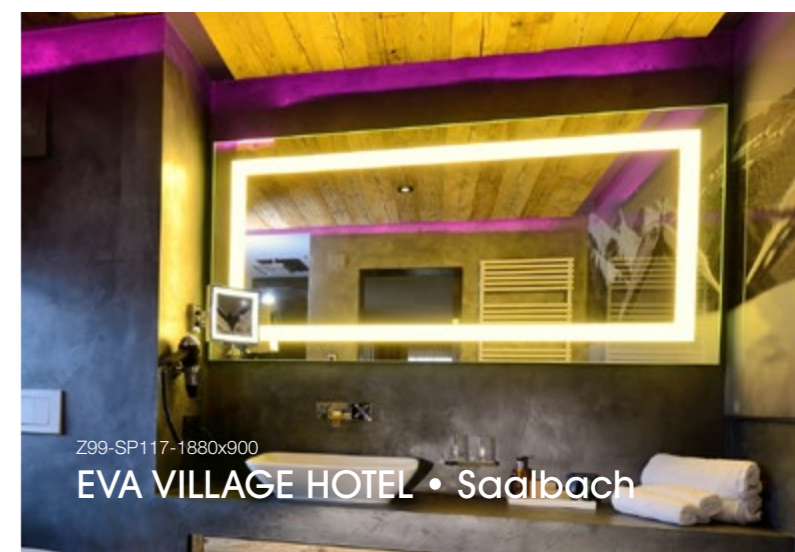

Z99-SP117-1880x900
EVA VILLAGE HOTEL • Saalbach

MIRRORS



CHENOT PALACE WEGGIS • Schweiz

ROOM NUMBERS



ZIMMER 8
ZIMMER 2
ZIMMER
(2.STOCK)
PANORAMA
301





Z99-W5629
HOTEL FRIESACHER • Salzburg



Z99-V4638
VOGLAUER MÖBELWERKE • Salzburg



Z99-W0528
HOTEL EDELWEISS • Hinterglemm



SORELL ST.PETER • Zürich



Z99-W1092-250
MARGARETHENHOF • Waakirchen

NUMBERS



Z99-W1096-1
HOTEL WALHALLA • Schweiz



Z99-W3381
SCHWARZER ADLER • Kitzbühel



Z99-H1450
HOTEL EDELWEISS • Wagrain



Z99-W5490
HOTEL ZUM OXN • Laufen

SIGNS





Z99-V0107-MAAHLZETT

TaNte FriDa - Family Hotel • Maria Alm

© Eder Hotels GmbH



Z747-HOTEL-EINGANG-HVKP

HOTEL GOLDENER HIRSCH • Salzburg

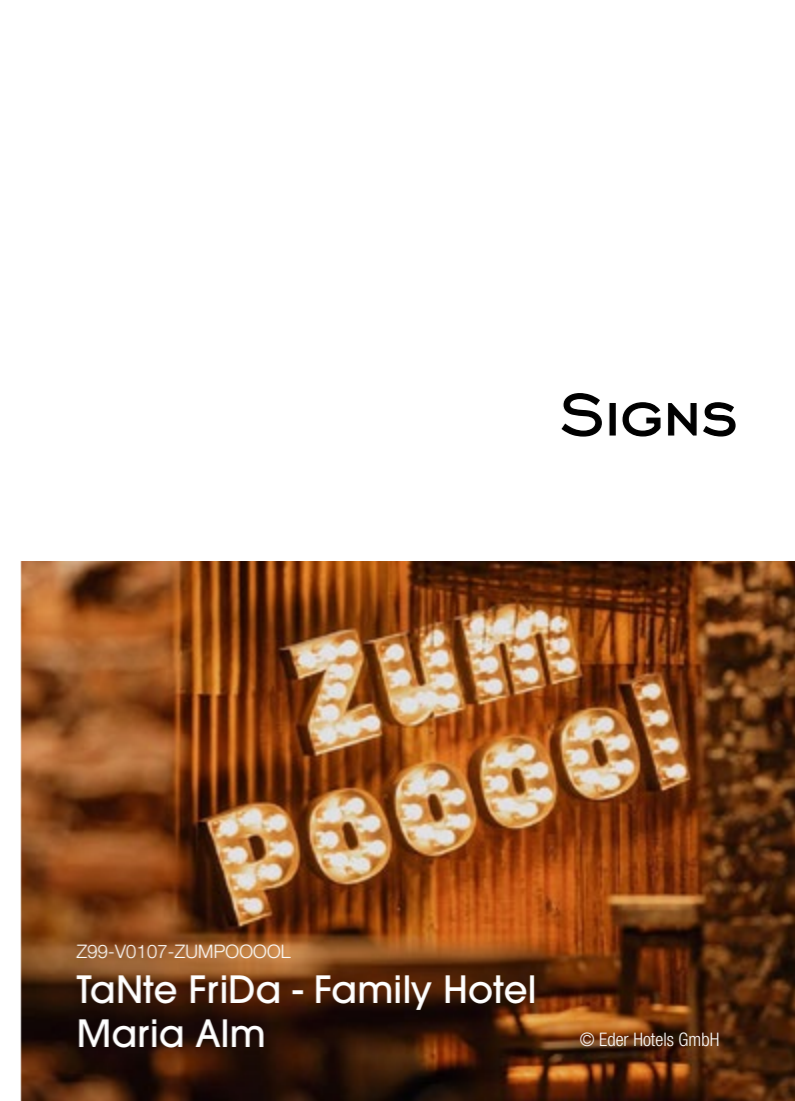

Z99-V0107-ZUMPOOOL

TaNte FriDa - Family Hotel
Maria Alm

SIGNS

© Eder Hotels GmbH



Z747-HERZL-HVKP

HOTEL GOLDENER HIRSCH • Salzburg



Z99-V0107-EMYSBAR • Z99-H0003

Bayerwaldresort Wellnesshotel Hüttenhof • Grainet



Z99-V2014
GMACHL • Bergheim

© Luigi Caputo



Z99-V2014
NIU HOTEL • Essen

© Jürgen Nobel

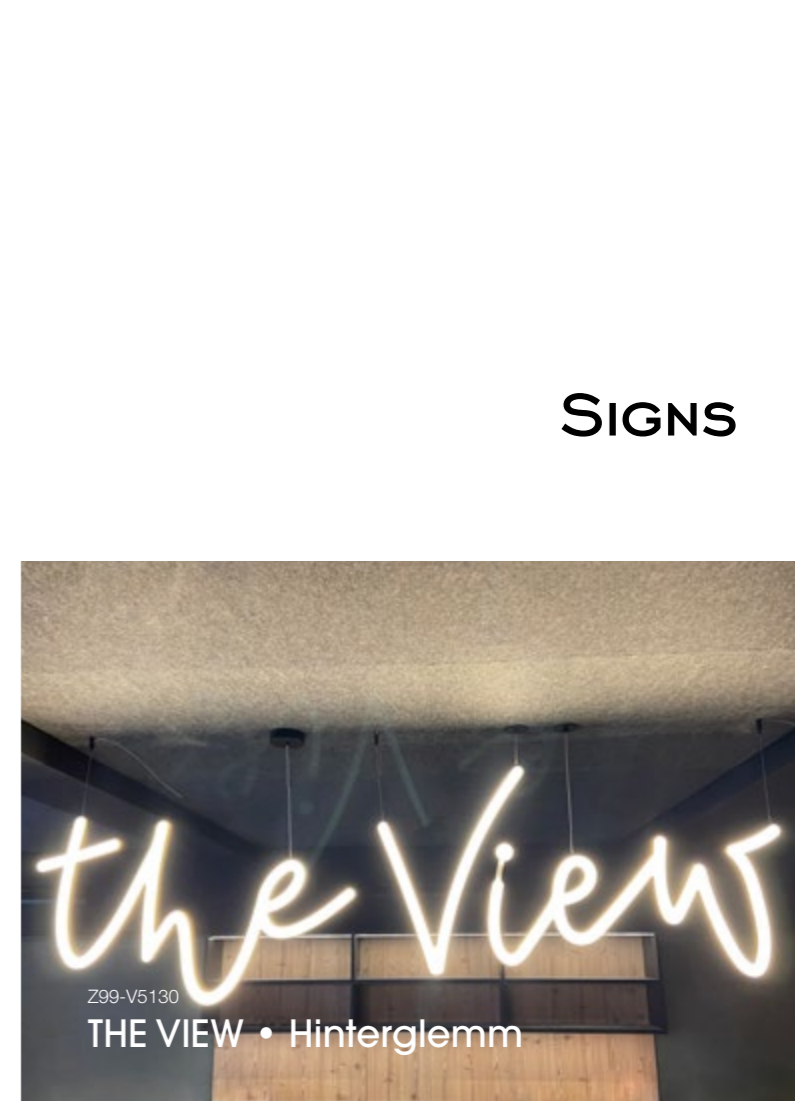

Z99-V5130
THE VIEW • Hinterglemm

SIGNS



Z747-HOTEL-GOLDENER-HIRSC-HVKP
HOTEL GOLDENER HIRSCH • Salzburg



Z99-V4394
ARCOTEL CASTELLANI • Salzburg

PROJECTS



PROJECTS



Z99-H5438
H&M • Düsseldorf

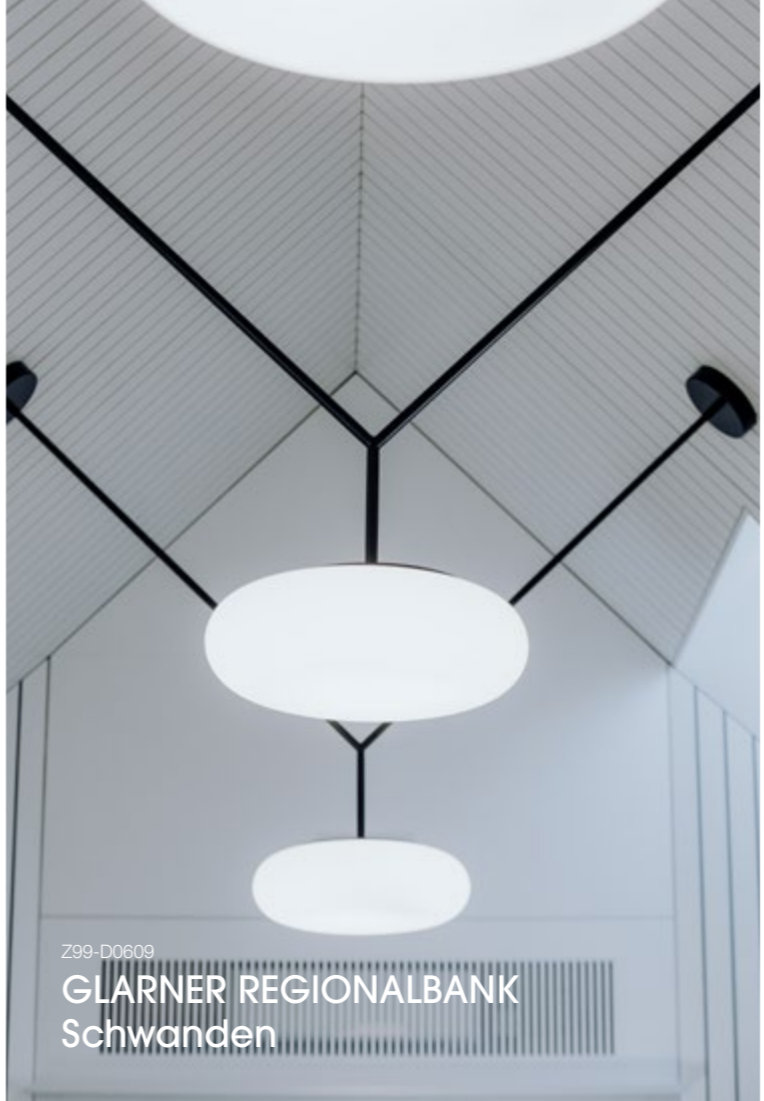

Z99-D0609
GLARNER REGIONALBANK
Schwanden



Z99-H1308-CHLOR
REISCHLHOF • Wegscheid



Z99-T0290
SCHLOSS FLEESESEE • Göhren - Lebbin

PROJECTS



Z99-CA-FD-07-2-LED-MB
STROLZ SPORT & MODE • Lech am Arlberg

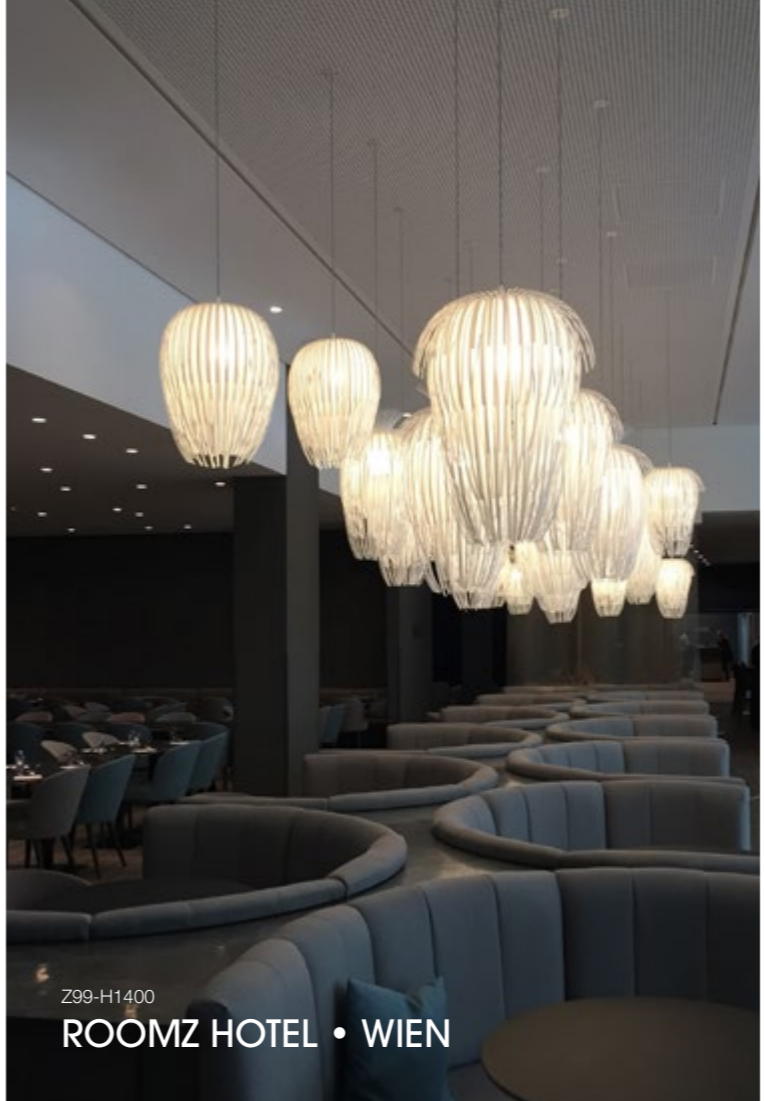

Z99-H1400
ROOMZ HOTEL • WIEN



Z99-D0070
ALMHOF • Gerloß

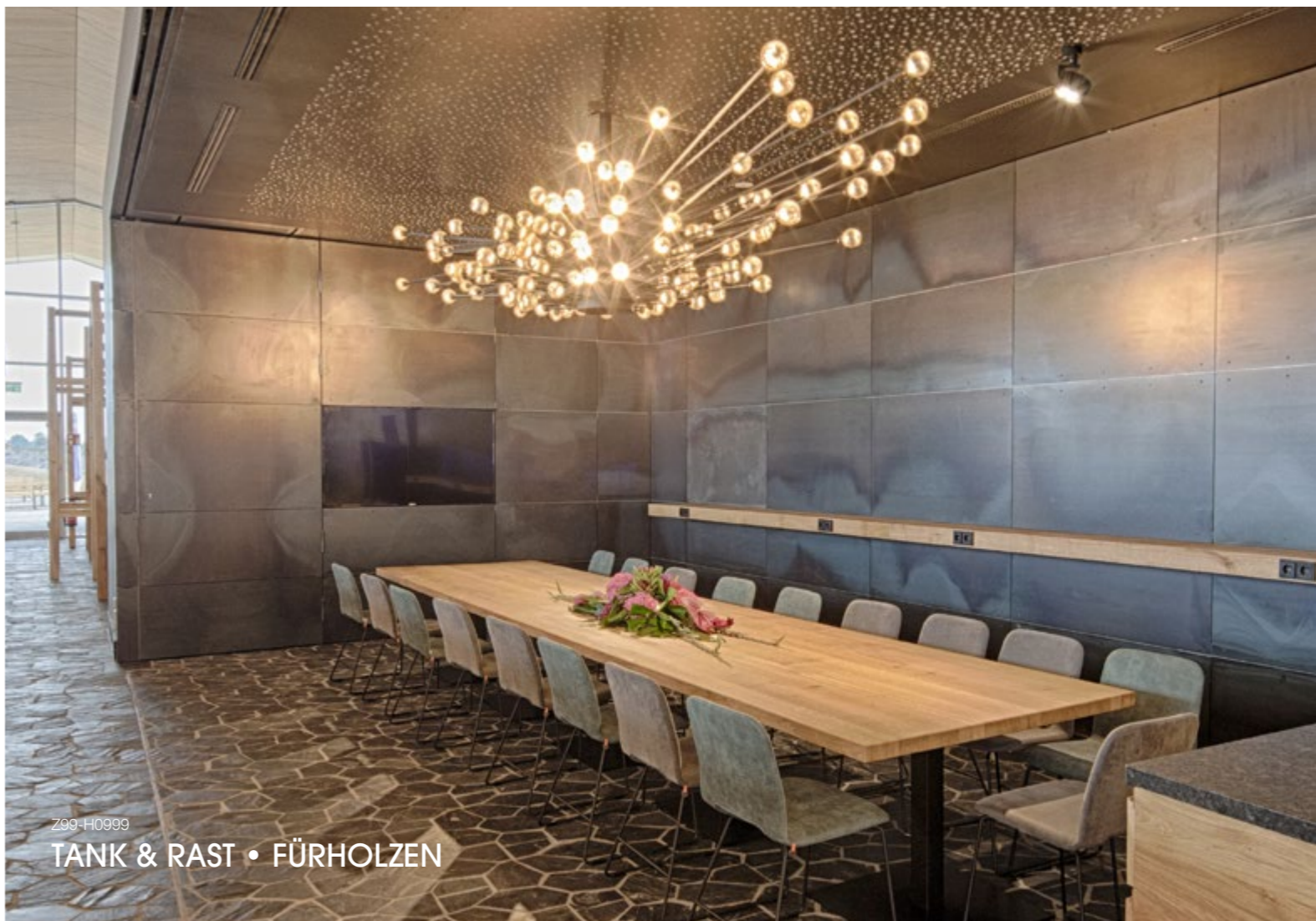

Z99-H0999
TANK & RAST • FÜRHOLZEN



Z99-H0327
A-JA • Grömitz



Z99-IF-232
HYATT • Dubai



Z99-D0330
STYLES HOTEL • Piding

PROJECTS



Z99-H5495-2 • Z99-W5590-2 • Z99-W5617-MGM
HOTEL FRIESACHER • Salzburg



Z99-H0261-2000-LED
TANK & RAST • Fürholzen



Z99-V3089
TANK & RAST • Vaterstetten



Z99-H0224-1200 • Z99-H0224-1600
TANK & RAST • Fürholzen



Z99-H1193-1000 • Z99-H1193-600
RADISSON HOTEL • Nürnberg

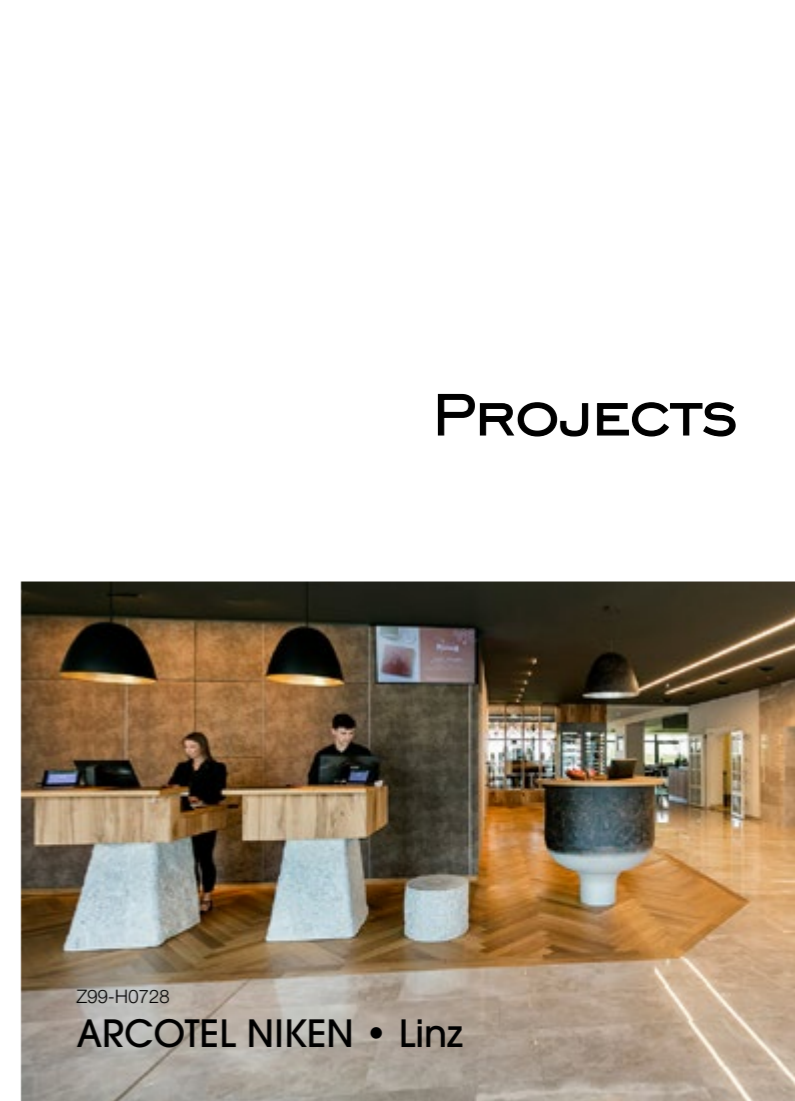

Z99-H0728
ARCOTEL NIKEN • Linz

PROJECTS

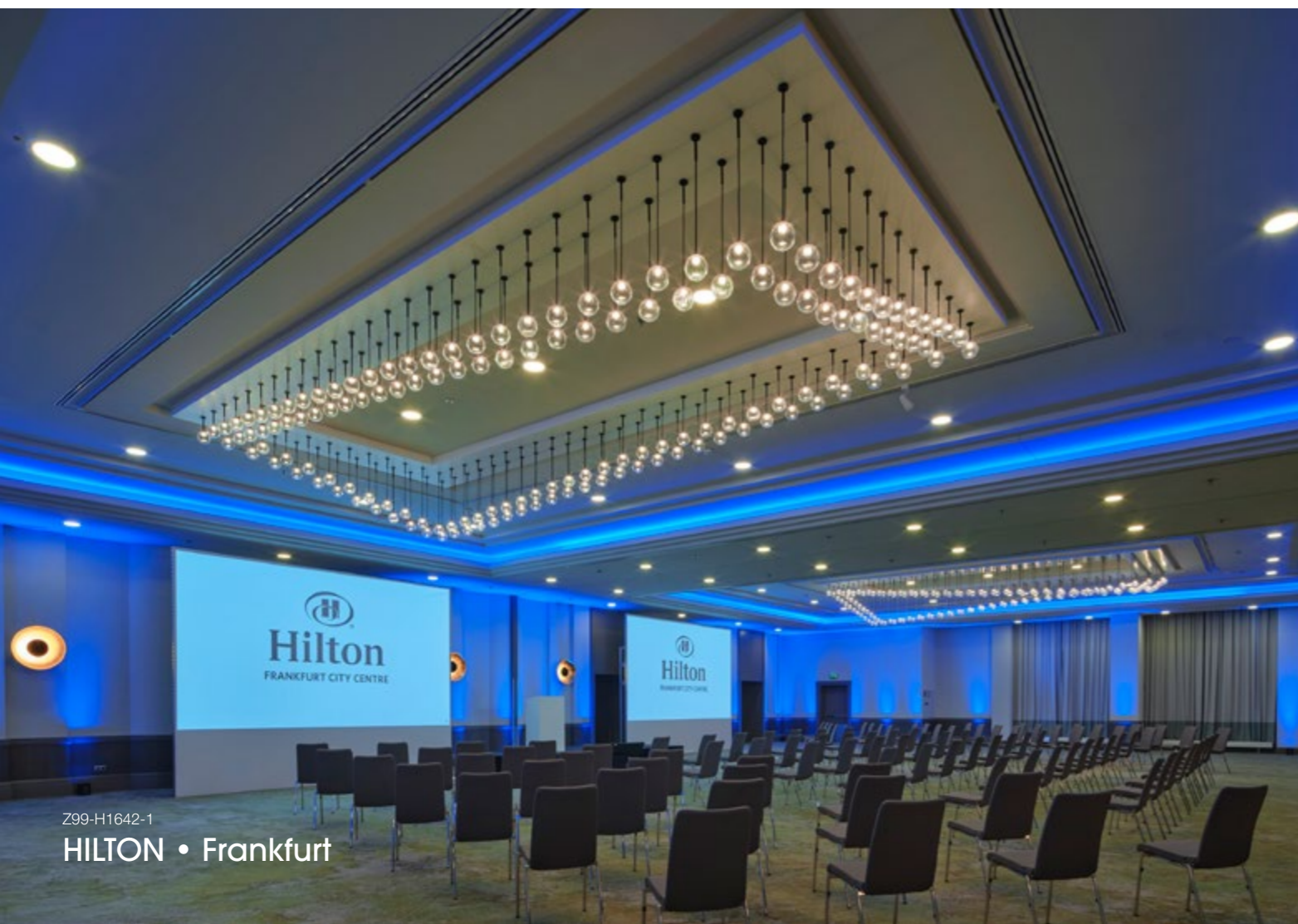

Z99-H1642-1
HILTON • Frankfurt



Z99-H1716-RZ25 • Z99-H1716-RZ72
STAY SPICED • Salzburg



Z99-D5489
HÜTTENDORF SCHLÖGELBERGER



Z99-H1308-CHLOR
REISCHLHOF • Wegscheid

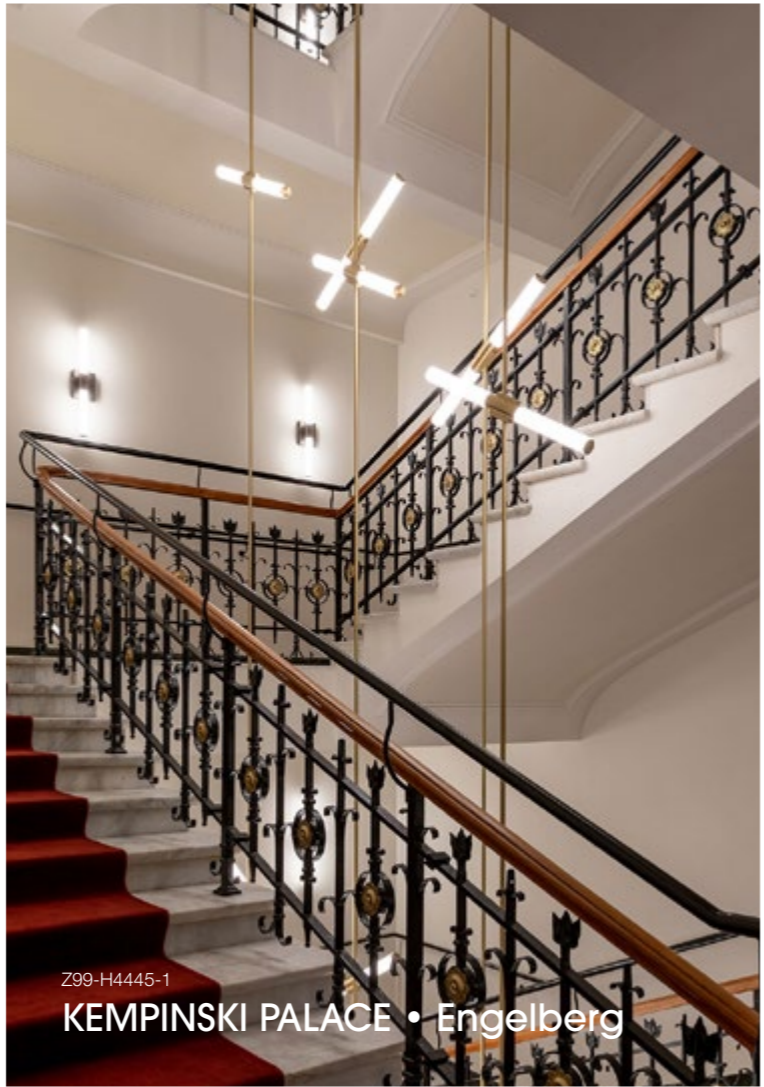

Z99-H4445-1
KEMPINSKI PALACE • Engelberg



Z99-H5460
STAATSOPER • Wien



Z99-H10981
TAURERWIRT • Großglockner

PROJECTS



Z99-H5460
BÜRGENSTOCK RESORT • Obbürgen



Z99-S0493-2-Typ1
KREISSPARKASSE • Eglingen



Z99-D0428-1
TAURERWIRT • Großglockner

LED-3-D5S-G-USB	261
Z99-ANG-D1	129
Z99-ANG-S1	128
Z99-ANG-T1	128
Z99-ANG-W1	129
Z99-BEA-B1	277
Z99-BEA-D1	277
Z99-BEA-W1	277
Z99-CUR-H1	147
Z99-CUR-H3	147
Z99-CUR-S1	146
Z99-CUR-T1	146
Z99-CUR-W2	147
Z99-D0359-1-600	123
Z99-D0382	73
Z99-D0382-1	73
Z99-D0612	77
Z99-D650-	59
Z99-D900-	59
Z99-D1134-800	63
Z99-D1200-	59
Z99-D1430-260	71
Z99-D1430-600	71
Z99-D1500-	59
Z99-D4637-500	65
Z99-D4674-400	61
Z99-D4674-600	61
Z99-D4674-1000	61
Z99-D4698-4-300	67
Z99-D4698-4-600	67
Z99-D4698-4-870	67
Z99-D4719	119
Z99-DEE-H6	151
Z99-DEE-H6-1	151
Z99-DEE-H8	151
Z99-DEE-W1-L	150
Z99-DEE-W1-R	150
Z99-DEE-W2	150
Z99-ECL-D1	155
Z99-ECL-H1	155
Z99-ECL-S1	154
Z99-ECL-T1	154
Z99-ECL-W1	155
Z99-GLO-D1	163
Z99-GLO-H1	163
Z99-GLO-S1	163
Z99-GLO-W1	163
Z99-GRA-H1	167
Z99-GRA-H2	167
Z99-GRA-S1	166
Z99-GRA-W1	166
Z99-GRM2-600	65
Z99-H0171	281
Z99-H0327-5-1200	79
Z99-H0328-4	79
Z99-H0354-2	115
Z99-H0354-10	115
Z99-H0400	115
Z99-H0416	121
Z99-H0647-10	111
Z99-H0647-11	111
Z99-H0647-12	111
Z99-H650-	83
Z99-H0651	77
Z99-H0664	275
Z99-H0664-1	275
Z99-H0664-2	275
Z99-H0692	271
Z99-H0693-1100	93

Z99-H0693-1500	93
Z99-H0706	95
Z99-H0728-1-300	107
Z99-H0728-1-400	107
Z99-H0728-1-550	107
Z99-H0762-6-2	125
Z99-H0767	91
Z99-H0778	95
Z99-H0779	95
Z99-H0796	113
Z99-H0796-1100	113
Z99-H0796-1100-2	113
Z99-H900-	83
Z99-H0918-2	91
Z99-H0943-1000	101
Z99-H0943-2300	101
Z99-H0972	107
Z99-H1200-	83
Z99-H1304	103
Z99-H1306-1985	73
Z99-H1310	119
Z99-H1310-1	119
Z99-H1312-1-600	85
Z99-H1312-1-1000	85
Z99-H1403-1	93
Z99-H1432-1	109
Z99-H1462-1	97
Z99-H1462-3	97
Z99-H1469-900	87
Z99-H1485	105
Z99-H1486	105
Z99-H1495	99
Z99-H1496	99
Z99-H1497	99
Z99-H1500-	83
Z99-H1530	123
Z99-H1582	87
Z99-H2046	89
Z99-H3891	71
Z99-H4469	87
Z99-H4482	125
Z99-H4484	125
Z99-H4512-1680	75
Z99-H4512-2300	75
Z99-H5410-1	91
Z99-H5443	89
Z99-H5743	97
Z99-H5785	109
Z99-H5786	109
Z99-H5787	109
Z99-HID-D1S	263
Z99-HIDDEN	263
Z99-HOL-H1	105
Z99-IF-12046-2	281
Z99-JUNO-DI	69
Z99-JUNO-DII	69
Z99-JUNO-DIII	69
Z99-LEN-D1	183
Z99-LEN-S1	183
Z99-LEN-W1	183
Z99-LTGH-100	21
Z99-MAL-H1	193
Z99-MAL-S1	192
Z99-MAL-T1	192
Z99-MAL-W1	193
Z99-MR141	39
Z99-MUG-D1-E27	199
Z99-MUG-D1-LED	199
Z99-MUG-D2-E27	199

































Z99-MUG-D2-LED	199
Z99-MUG-D3-E27	199
Z99-MUG-D3-LED	199
Z99-MUG-D4-E27	199
Z99-MUG-H1	198
Z99-MUG-LED	199
Z99-MUG-S1	196
Z99-MUG-T1	196
Z99-MUG-T2	196
Z99-MUG-W1	197
Z99-MUG-W2	197
Z99-MUG-W3	197
Z99-NEW-D1	209
Z99-NEW-S1	208
Z99-NEW-T1	208
Z99-NEW-W1	209
Z99-ORB-H1	213
Z99-ORB-H2	213
Z99-ORB-S1	212
Z99-ORB-W1	212
Z99-ORB-W2	212
Z99-OSL-H1	217
Z99-OSL-S1	217
Z99-OSL-W1	217
Z99-PAR-D1	223
Z99-PAR-H1	223
Z99-PAR-S1	221
Z99-PAR-S2	221
Z99-PAR-T1	220
Z99-PAR-T2	220
Z99-PBU-H1	135
Z99-PBU-H2	135
Z99-PBU-S1	133
Z99-PBU-S1-6	133
Z99-PBU-T1	132
Z99-PBU-T2	132
Z99-PBU-W1	135
Z99-PCO-D1-E27	143
Z99-PCO-D1-LED	143
Z99-PCO-D2-E27	143
Z99-PCO-D2-LED	143
Z99-PCO-D3-E27	143
Z99-PCO-D3-LED	143
Z99-PCO-D4-E27	143
Z99-PCO-D4-LED	143
Z99-PCO-H1	142
Z99-PCO-H2	142
Z99-PCO-S1	138
Z99-PCO-T1	138
Z99-PCO-T2	138
Z99-PCO-W1	139
Z99-PCO-W1-2	139
Z99-PCO-W1-3	139
Z99-PCO-W2	141
Z99-PCO-W2-EINBAU	141
Z99-PEL-D2-E27	159
Z99-PEL-D2-LED	159
Z99-PEL-H3	159
Z99-PEL-S1	158
Z99-PEL-T1	158
Z99-PEL-W1-2	159
Z99-PHA-D1-E27	173
Z99-PHA-D1-LED	173
Z99-PHA-D2-E27	173
Z99-PHA-D2-LED	173
Z99-PHA-D3-E27	173
Z99-PHA-D3-LED	173
Z99-PHA-D4-E27	173
Z99-PHA-D4-LED	173

Z99-PHA-S1	170
Z99-PHA-T1	170
Z99-PHA-T2	170
Z99-PHA-W1	171
Z99-PHA-W1-2	171
Z99-PHA-W1-3	171
Z99-PIPE	263
Z99-PKU-D1-E27	179
Z99-PKU-D1-LED	179
Z99-PKU-D2-E27	179
Z99-PKU-D2-LED	179
Z99-PKU-D3-E27	179
Z99-PKU-D3-LED	179
Z99-PKU-D4-E27	179
Z99-PKU-D4-LED	179
Z99-PKU-H2-2	178
Z99-PKU-H3	178
Z99-PKU-S1	177
Z99-PKU-T1	177
Z99-PKU-W1	177
Z99-PKU-W2	177
Z99-PLO-D1-E27	189
Z99-PLO-D1-LED	189
Z99-PLO-D2-E27	189
Z99-PLO-D2-LED	189
Z99-PLO-D3-E27	189
Z99-PLO-D3-LED	189
Z99-PLO-D4-180-1-E27	63
Z99-PLO-D4-180-1-LED	63
Z99-PLO-D4-E27	189
Z99-PLO-D4-LED	189
Z99-PLO-H1	188
Z99-PLO-H2	188
Z99-PLO-H6	188
Z99-PLO-S1	186
Z99-PLO-T1	186
Z99-PLO-T2	186
Z99-PLO-W1	187
Z99-PLO-W1-3	187
Z99-PMO-W1-LED	259
Z99-PMO-W2-LED	259
Z99-PNA-D1-E27	205
Z99-PNA-D1-LED	205
Z99-PNA-D2-E27	205
Z99-PNA-D2-LED	205
Z99-PNA-D3-E27	205
Z99-PNA-D3-LED	205
Z99-PNA-D4-E27	205
Z99-PNA-D4-LED	205
Z99-PNA-H2	204
Z99-PNA-S1	202
Z99-PNA-T3	202
Z99-PNA-T4	202
Z99-PNA-W3	203
Z99-PNA-W4	203
Z99-PNA-W5	203
Z99-PPE-D1-E27	231
Z99-PPE-D1-LED	231
Z99-PPE-D2-E27	231
Z99-PPE-D2-LED	231
Z99-PPE-D3-E27	231
Z99-PPE-D3-LED	231
Z99-PPE-D4-E27	231
Z99-PPE-D4-LED	231
Z99-PPE-H1	230
Z99-PPE-H2	230
Z99-PPE-S1	226
Z99-PPE-T1	226
Z99-PPE-T2	226

Z99-PPE-W1	227
Z99-PPE-W1-2	227
Z99-PPE-W1-3	227
Z99-PPE-W2	229
Z99-PPE-W6	229
Z99-PRI-D1	235
Z99-PRI-H1	237
Z99-PRI-H2	237
Z99-PRI-S1	234
Z99-PRI-T1	234
Z99-PRI-W1	235
Z99-PRU-D1-E27	243
Z99-PRU-D1-LED	243
Z99-PRU-D2-E27	243
Z99-PRU-D2-LED	243
Z99-PRU-D3-E27	243
Z99-PRU-D3-LED	243
Z99-PRU-D4-E27	243
Z99-PRU-D4-LED	243
Z99-PRU-H1	242
Z99-PRU-H2	242
Z99-PRU-S1	240
Z99-PRU-T1	240
Z99-PRU-T2	240
Z99-PRU-W1	241
Z99-PRU-W1-2	241
Z99-PRU-W1-3	241
Z99-PSE-D1-E27	251
Z99-PSE-D1-LED	251
Z99-PSE-D2-E27	251
Z99-PSE-D2-LED	251
Z99-PSE-D3-E27	251
Z99-PSE-D3-LED	251
Z99-PSE-D4-E27	251
Z99-PSE-D4-LED	251
Z99-PSE-H1	250
Z99-PSE-H2	250
Z99-PSE-S1	246
Z99-PSE-T1	246
Z99-PSE-T2	246
Z99-PSE-W1	247
Z99-PSE-W1-2	247
Z99-PSE-W1-3	247
Z99-PSE-W2	249
Z99-PULPO-L	261
Z99-PULPO-R	261
Z99-S0169-3	55
Z99-S0255	271
Z99-S0438	273
Z99-S0473	49
Z99-S0474	49
Z99-S0490-1	49
Z99-S0516-1	279
Z99-S0535-1400	47
Z99-S0535-1720	47
Z99-S1064-1430	53
Z99-S4129-10	51
Z99-S4129-41	51
Z99-S4723	53
Z99-S5002	283
Z99-S5002-1	283
Z99-S5002-2	283
Z99-SP192-900	293
Z99-SP199-1	293
Z99-SP209	293
Z99-T0227	39
Z99-T0244-1	43
Z99-T0399-5	43
Z99-T0399-7	43

Z99-T0416-1	39
Z99-T0498-1	39
Z99-T0502	35
Z99-T0548-2	37
Z99-T1015-500	35
Z99-T4185-1	37
Z99-T4674-1	37
Z99-T4911	41
Z99-TAP-H1	255
Z99-TAP-S1	254
Z99-TAP-T1	254
Z99-TAP-W1	255
Z99-VIN-H1	117
Z99-VIN-H2	117
Z99-VIN-H3	117
Z99-VIN-H7	117
Z99-W0207-1	273
Z99-W0221-3	29
Z99-W0221-4	29
Z99-W0276	31
Z99-W0420-L-1	25
Z99-W0420-R-1	25
Z99-W0460-1	23
Z99-W0461-3	17
Z99-W0489-1	281
Z99-W0489-2	281
Z99-W0550-1	19
Z99-W0721-4	27
Z99-W0781	17
Z99-W0808-1200	31
Z99-W0947	27
Z99-W0953-1	19
Z99-W0955	19
Z99-W1586-1	23
Z99-W1603-1	21
Z99-W3199-1	17
Z99-W5460-6	21
Z99-W5478-1	21
Z99-W5497	17
Z99-W5541	27
Z99-W5543	23
Z99-W5582	31
Z99-W5643	23
Z99-W5643	65
Z587-2035LT	285
Z587-2136LT	285
Z587-2296LS	285
Z801-F1001-360A	288
Z801-F1002-360A	288
Z801-F1010-300B	289
Z801-F1010-500B	289
Z801-F1100-360B	288

SEARCH

Symbol	Beschreibung	Symbol	Beschreibung
	Leuchte wird mit Wippschalter geliefert		Betriebsgerät ist in der Leuchte verbaut
	Leuchte wird mit Drucktaster geliefert		DALI steht für "Digital Addressable Lighting Interface" und ist ein Protokoll für die standardisierte digitale Betriebsgerätschnittstelle der NORM IEC 62386
	Leuchte wird mit Kippschalter geliefert		Leuchte nicht dimmbar
	Leuchte wird ohne Schalter geliefert		Leuchte wird mit Kabelschalter und einer Kabellänge von 2m mit Stecker ausgeliefert
	Geschützt gegen feste Fremdkörper mit Durchmesser 12,5mm (Geschützt gegen den Zugang mit einem Finger) Kein Schutz gegen Wasser		Leuchte wird mit Fußschalter und einer Kabellänge von 2m mit Stecker ausgeliefert
	Geschützt gegen feste Fremdkörper mit Durchmesser 1mm / geschützt gegen den Zugang mit einem Draht Schutz gegen allseitiges Spritzwasser		Ladung mit USB Schnittstelle
	Geschützt gegen Staub in schädigender Menge (vollständiger Schutz gegen Berührung) Schutz gegen allseitiges Spritzwasser		In der Leuchte ist eine USB-A Schnittstelle verbaut
	Staubdicht (vollständiger Schutz gegen Berührung) Schutz gegen allseitiges Spritzwasser		Für die Leuchte ist ein Globe 125 Leuchtmittel vorgesehen (Fassung E27)
	Staubdicht (vollständiger Schutz gegen Berührung) Schutz gegen Strahlwasser (Düse) aus beliebigem Winkel		Drehbereich der Leuchte
	Leuchtdauer der Akkuleuchte 9 Stunden bei 100%		Schwenkbereich der Leuchte
	Ladezeit der Akkuleuchte 6 Stunden		Stoffgruppe 1, 2 und 3 möglich
	Betriebsspannung Akku 3,7 Volt		Wand - Einbauleuchte
	Betriebsspannung 24 Volt		Direkte Leuchtquelle
	Betriebsspannung 230 Volt		Indirekte Leuchtquelle
	LED Chip Leistung 2 Watt		
	Lichtstärke des Leuchtmittels 160 Lumen		
	Farbtemperatur des Leuchtmittels 2700 Kelvin		
	Betriebsgerät muss außerhalb der Lampe verbaut werden		

WIR GEBEN DEM LICHT EMOTION

Die Technik ist zwar wichtig für uns als Produzent, jedoch Nebensache für unsere Kunden, die mit dem Licht leben und es nur ein- und ausschalten wollen.

Wir bauen das Licht für Menschen und müssen daher mit dem, was die elektrische Beleuchtung beim Menschen an Gefühlen auslöst, sehr behutsam umgehen. Schließlich war der Mensch Jahrtausende lang nur an die Sonne und offenes Feuer als Lichtquellen gewöhnt.

Diese evolutionäre Prägung kann nicht bloß durch eine 135 Jahre alte Glühlampe ausgelöscht werden.

Hans Buchegger
(Geschäftsführer & Inhaber)

Medieninhaber: 2F-Leuchten Ges.m.b.H., Pichl 118, A-5441 Abtenau
Geschäftsführer: Johann Buchegger
Idee, Text & Design: 2F-Leuchten Ges.m.b.H.
Grafik Design: Hubert Reiter • 2F-Leuchten Ges.m.b.H.
Bildnachweis: stock.adobe..com • 2F Leuchten Ges.m.b.H.

Alle Angaben in diesem Katalog entsprechen dem aktuellen Stand bei Drucklegung (Mai 2022). Für Farbabweichungen oder eventuelle Druckfehler übernehmen wir keine Haftung. 2F-Leuchten behält sich das Recht vor, konstruktive Änderungen zur Verbesserung unserer, in diesem Katalog abgebildeten Produkte, jederzeit und ohne Ankündigung durchzuführen.

Es gelten unsere allgemeinen Geschäftsbedingungen, einsehbar unter www.2f-leuchten.com/de/unternehmen/agba.



ZENTRALE:
2F LEUCHTEN Ges.m.b.H
Pichl 118 | A-5441 Abtenau | +43 6243 2407 0
office@2f-leuchten.com | www.2f-leuchten.com



NIEDERLASSUNG SWITZERLAND:
2F LEUCHTEN GmbH
Spinnereistrasse 5 | CH-6020 Emmenbrücke | +41 41 260 72 71
schweiz@2f-leuchten.com | www.2f-leuchten.com



